

This booklet is a compilation from many sources. Its purpose is to help boy scouts. It is not for sale. No legal rights implied. If anyone has a legal claim to any of this art work, I will gladly remove it from the booklet. If you would like to include additional art, please email rcano@bellsouth.net, Revised June 18, 2004.

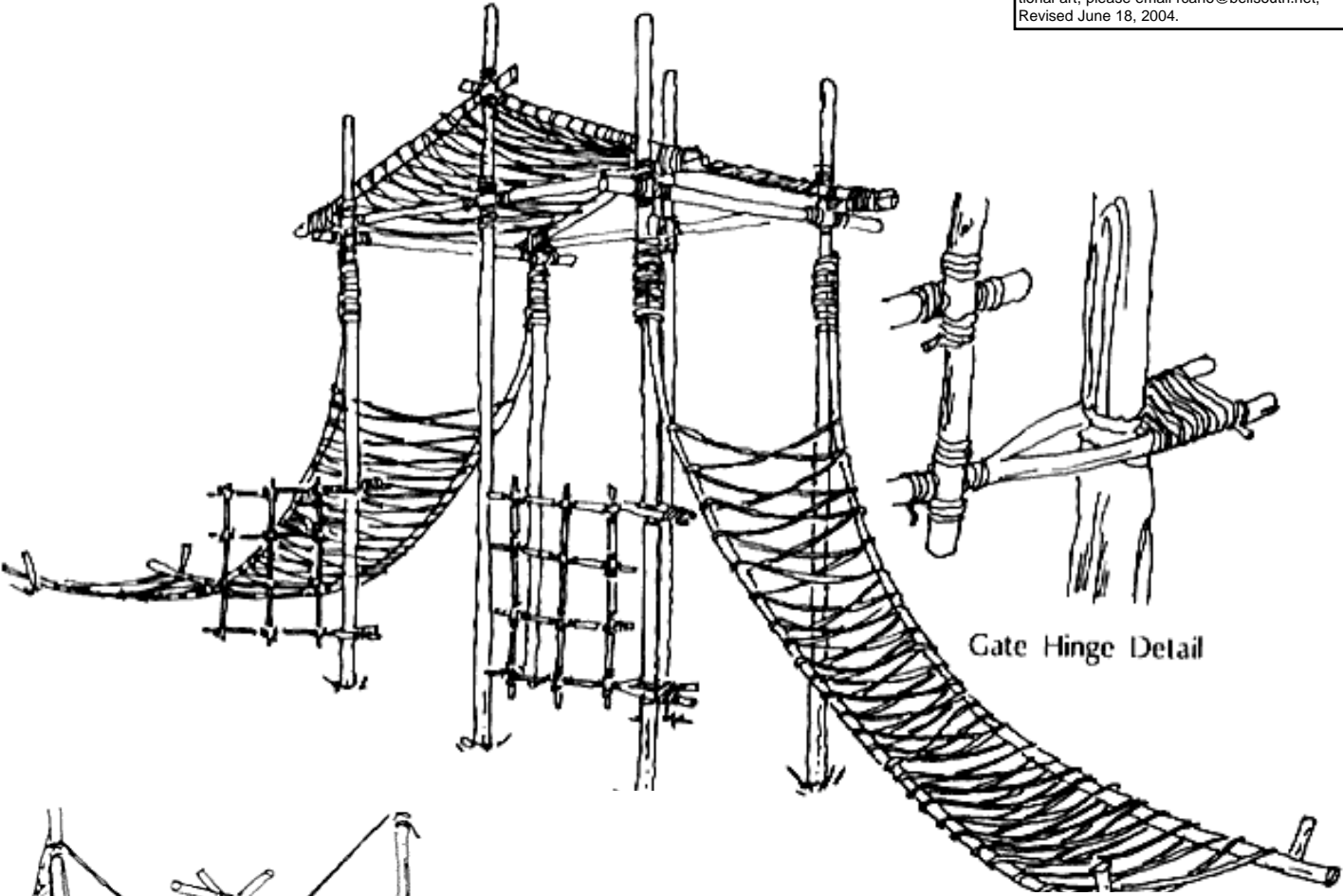

Gate Hinge Detail

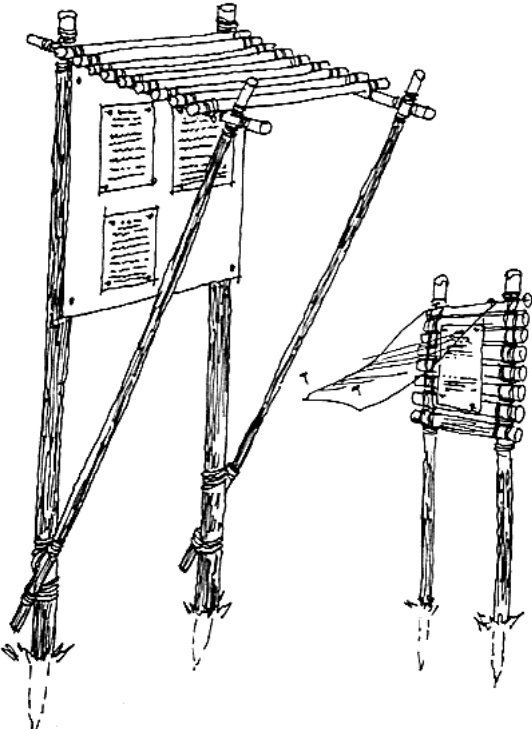

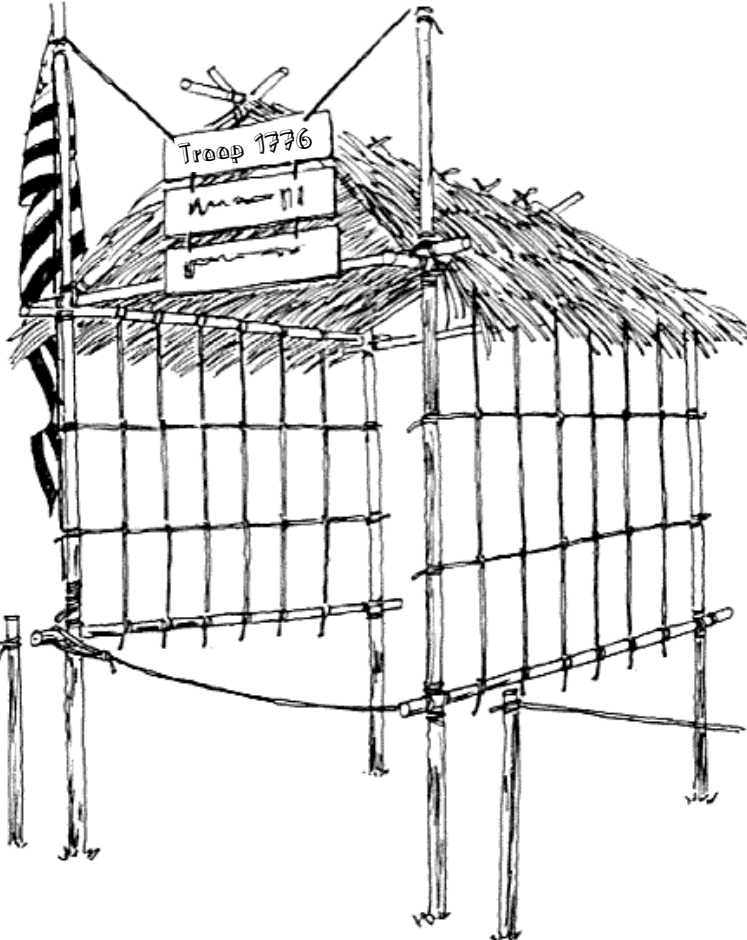
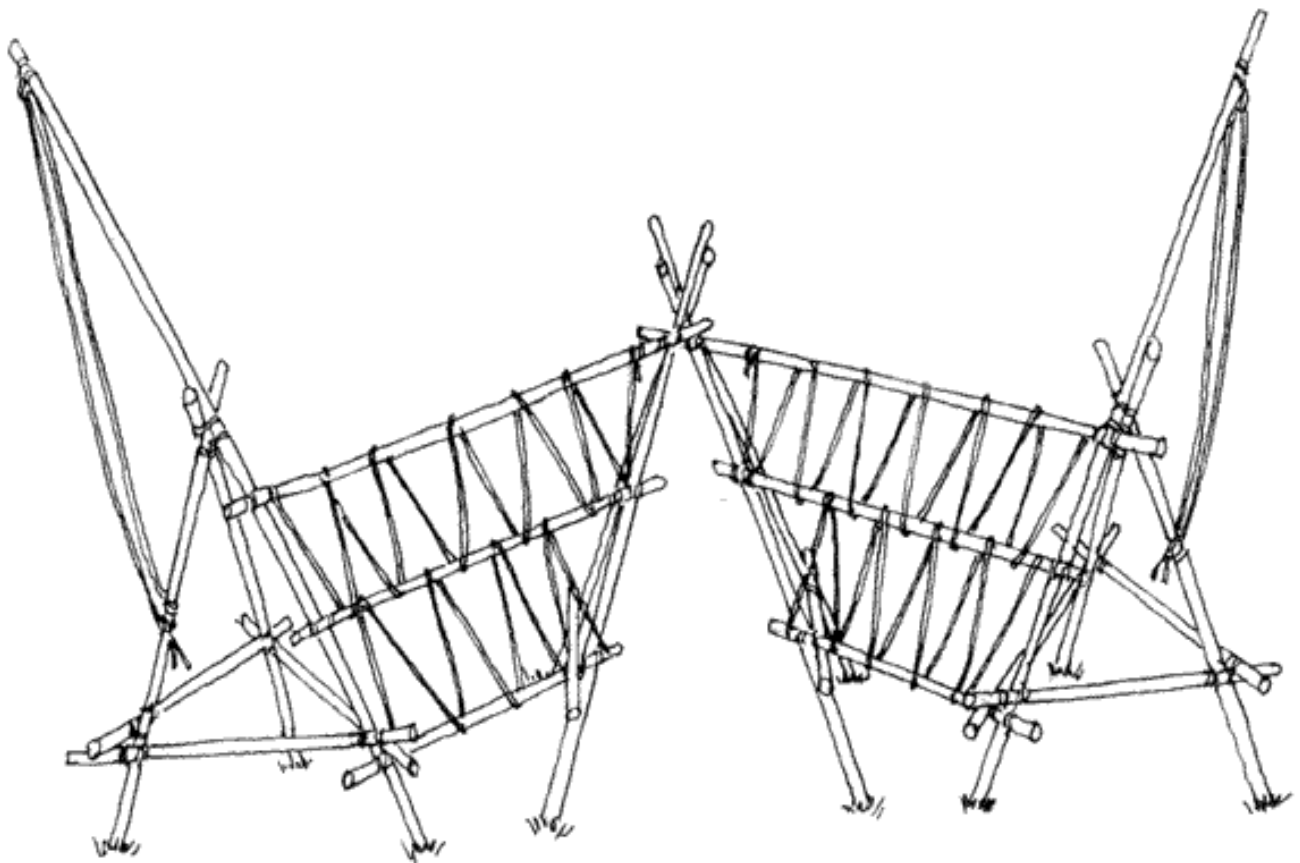
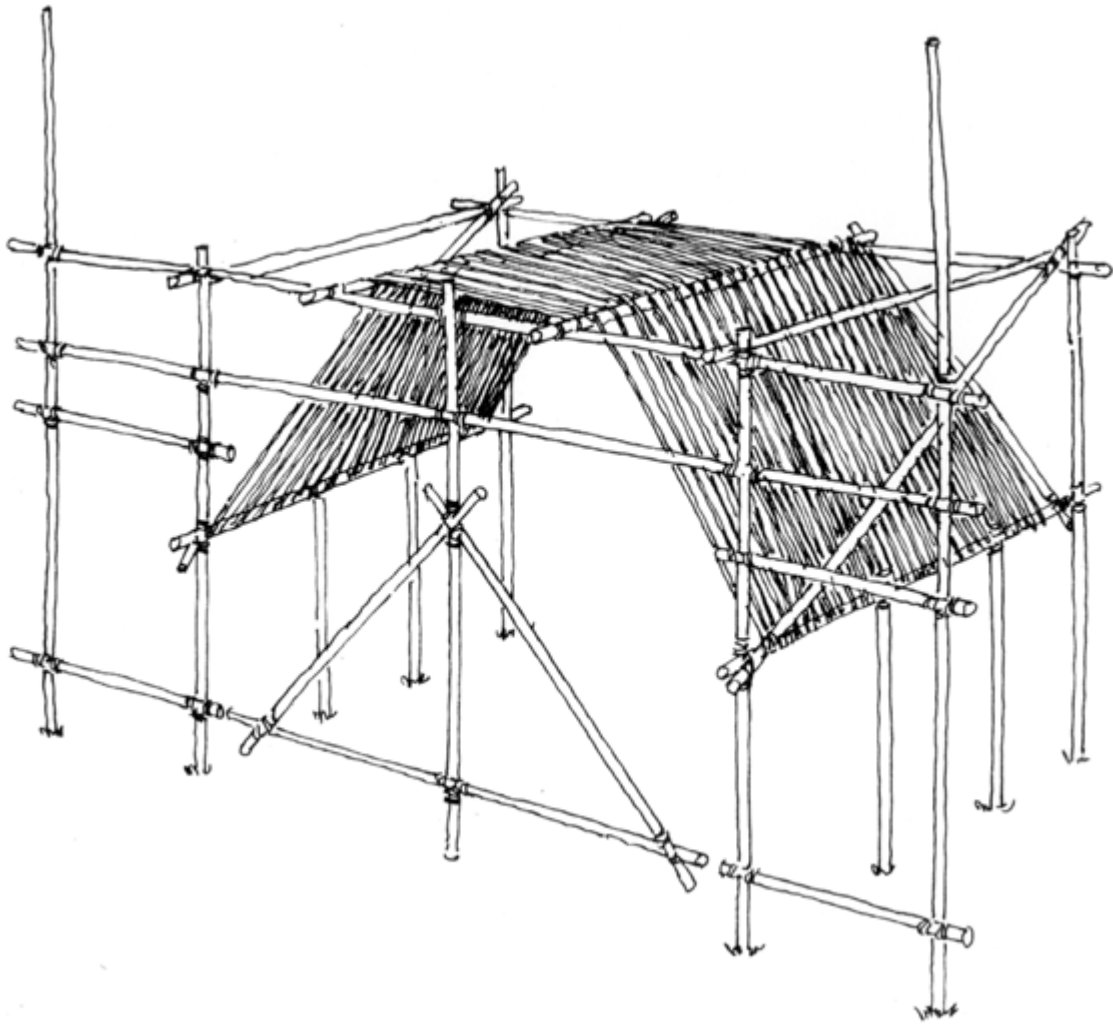

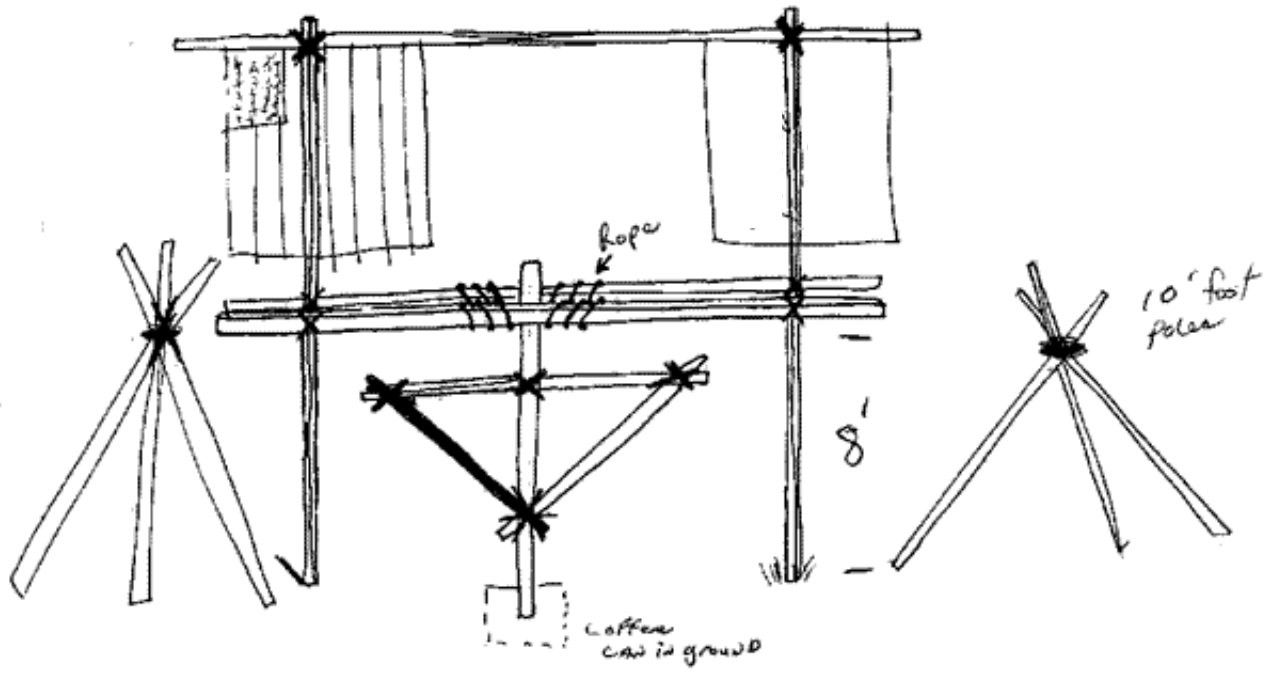

Rotating Gate
Turnstile Gate

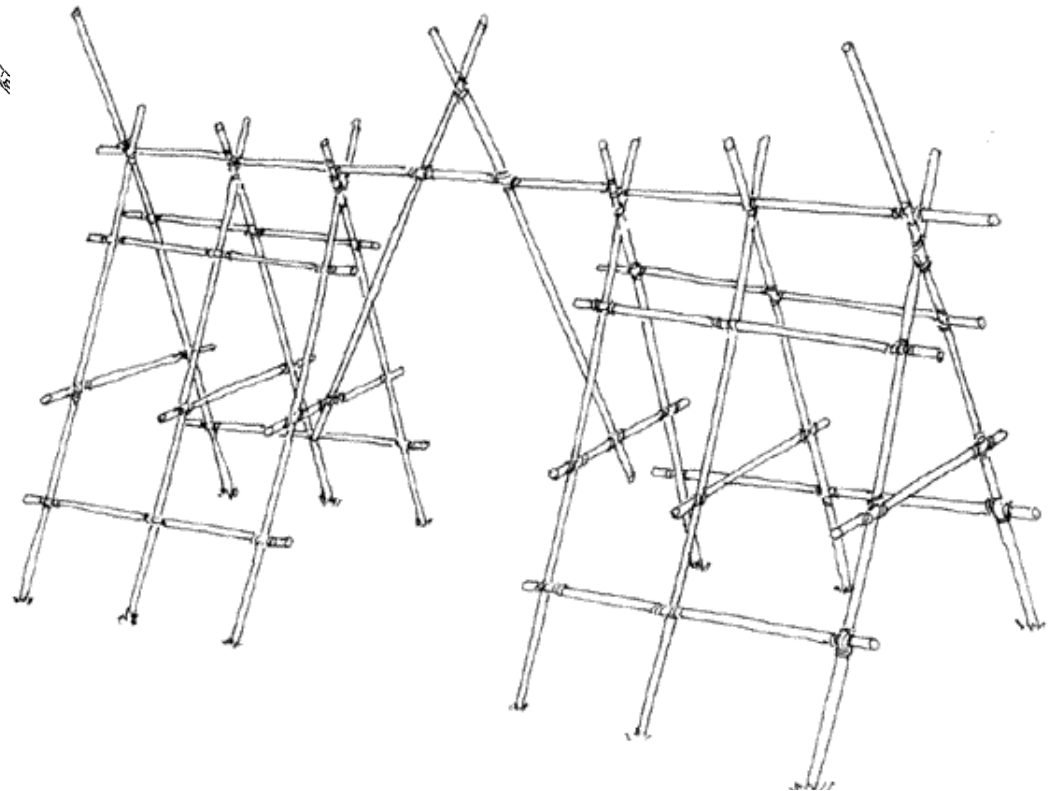
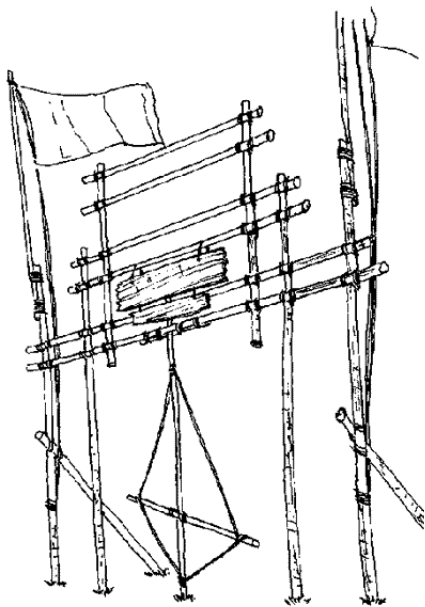

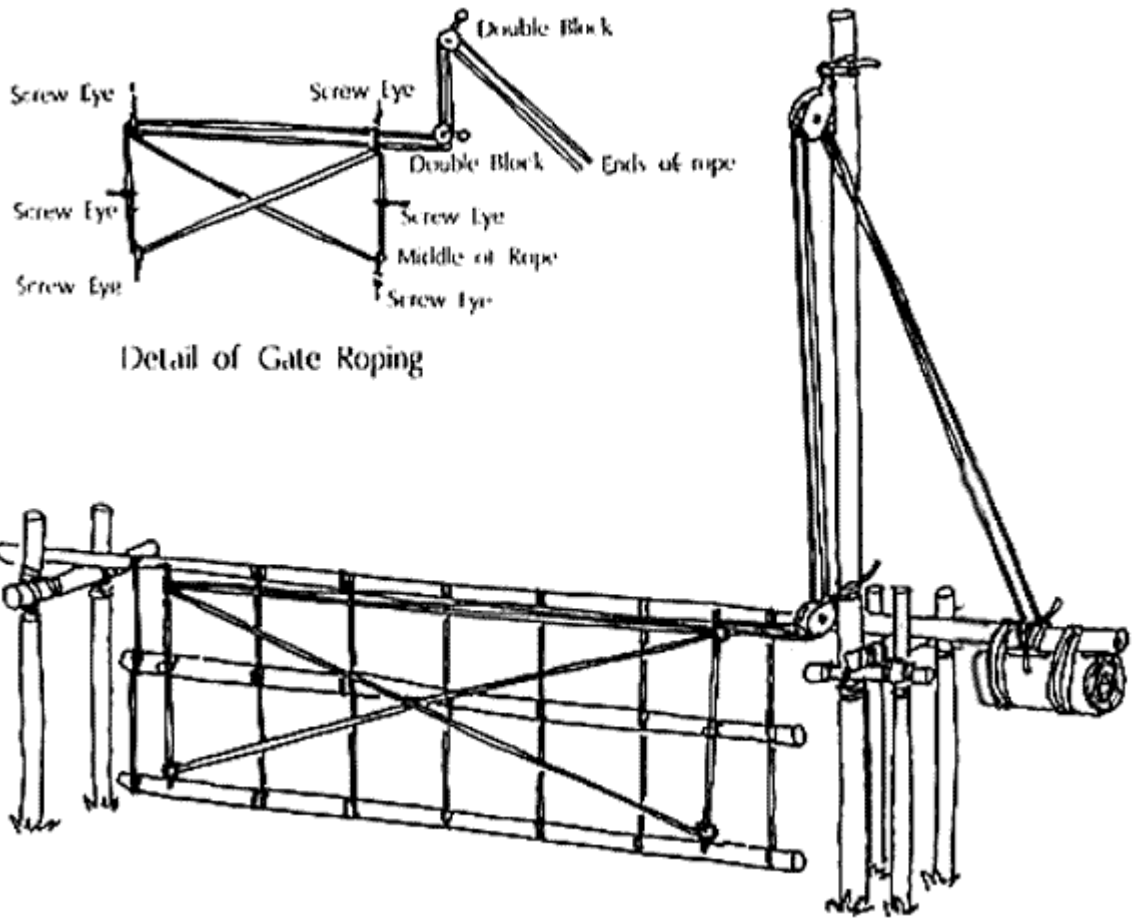

Detail of Gate Roping

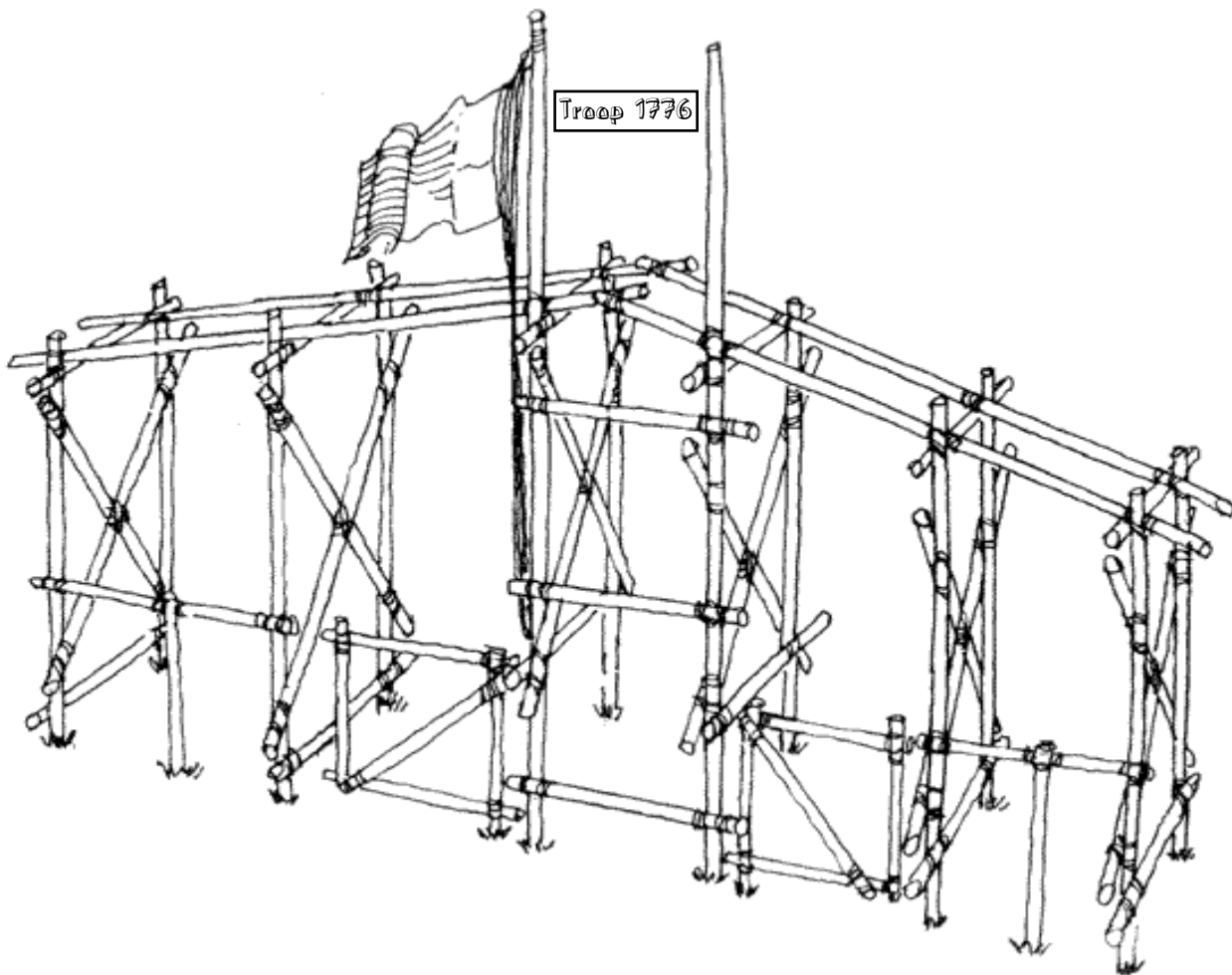

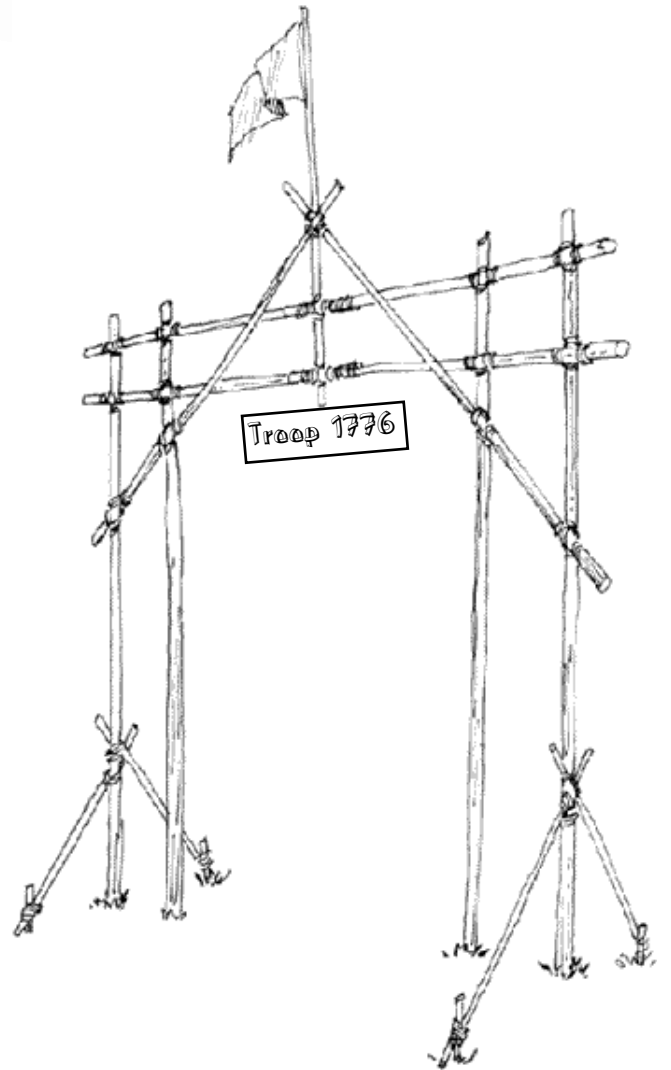
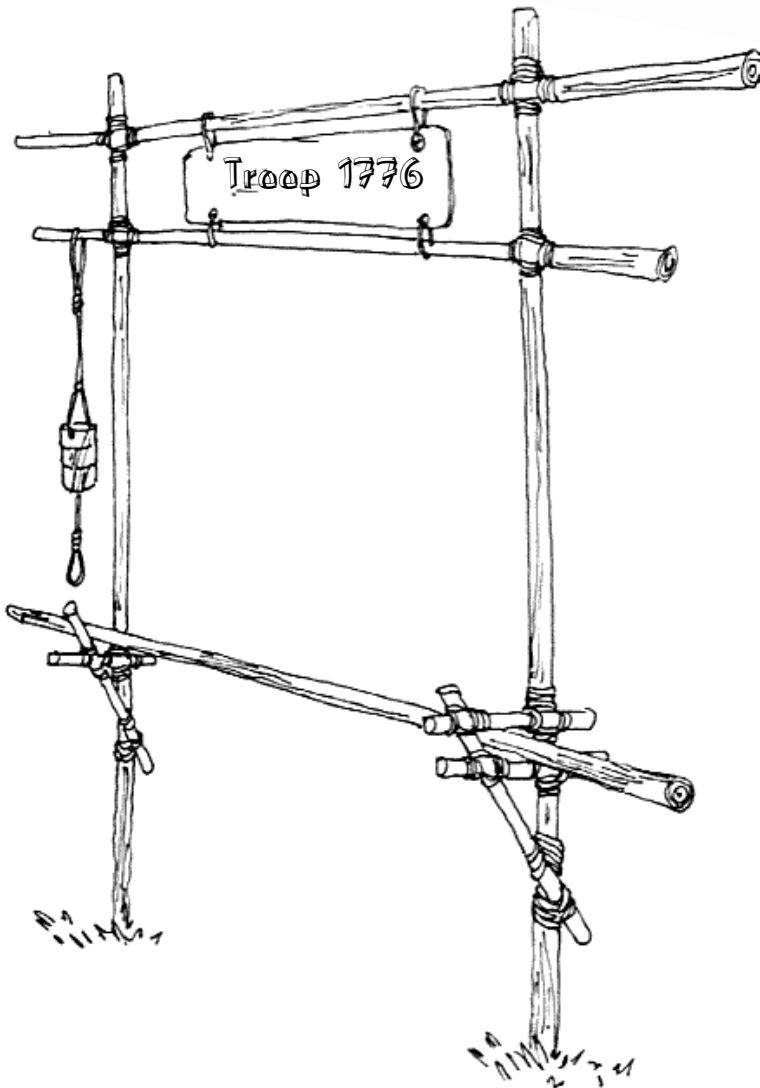
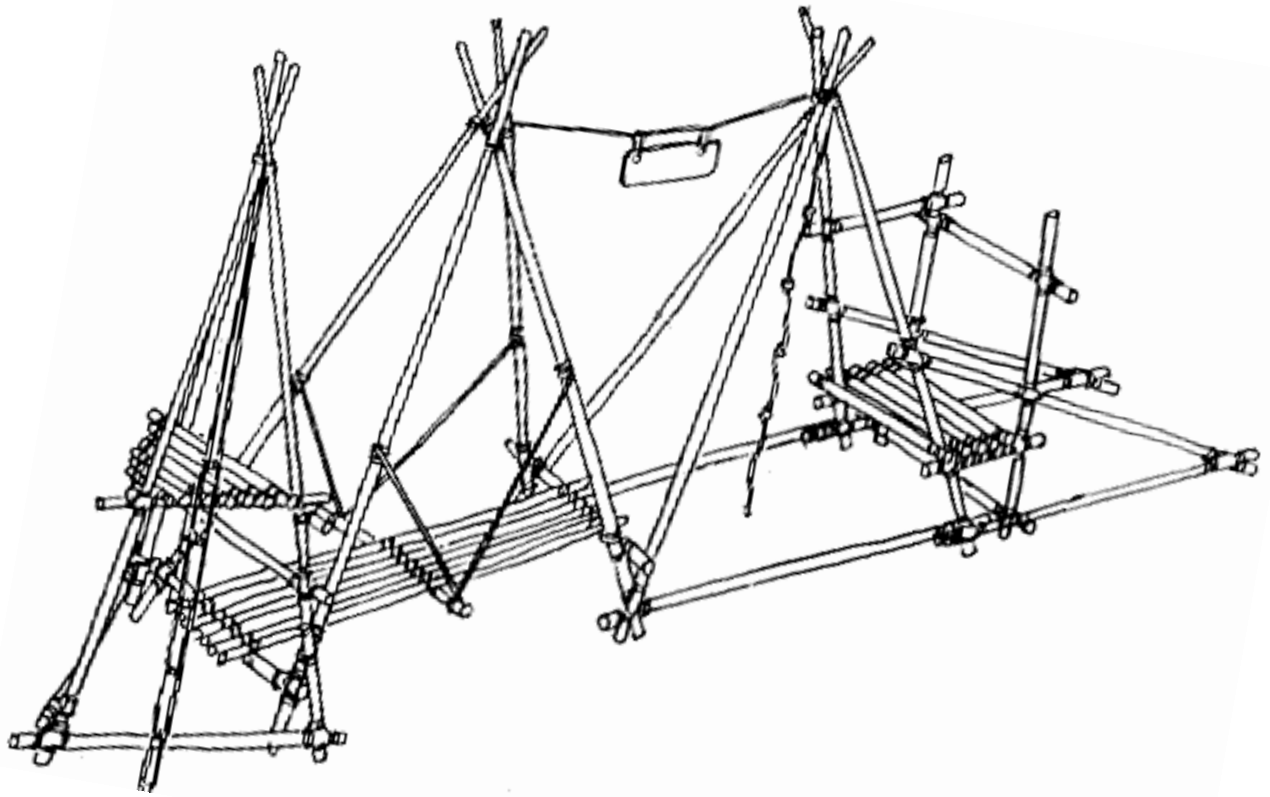

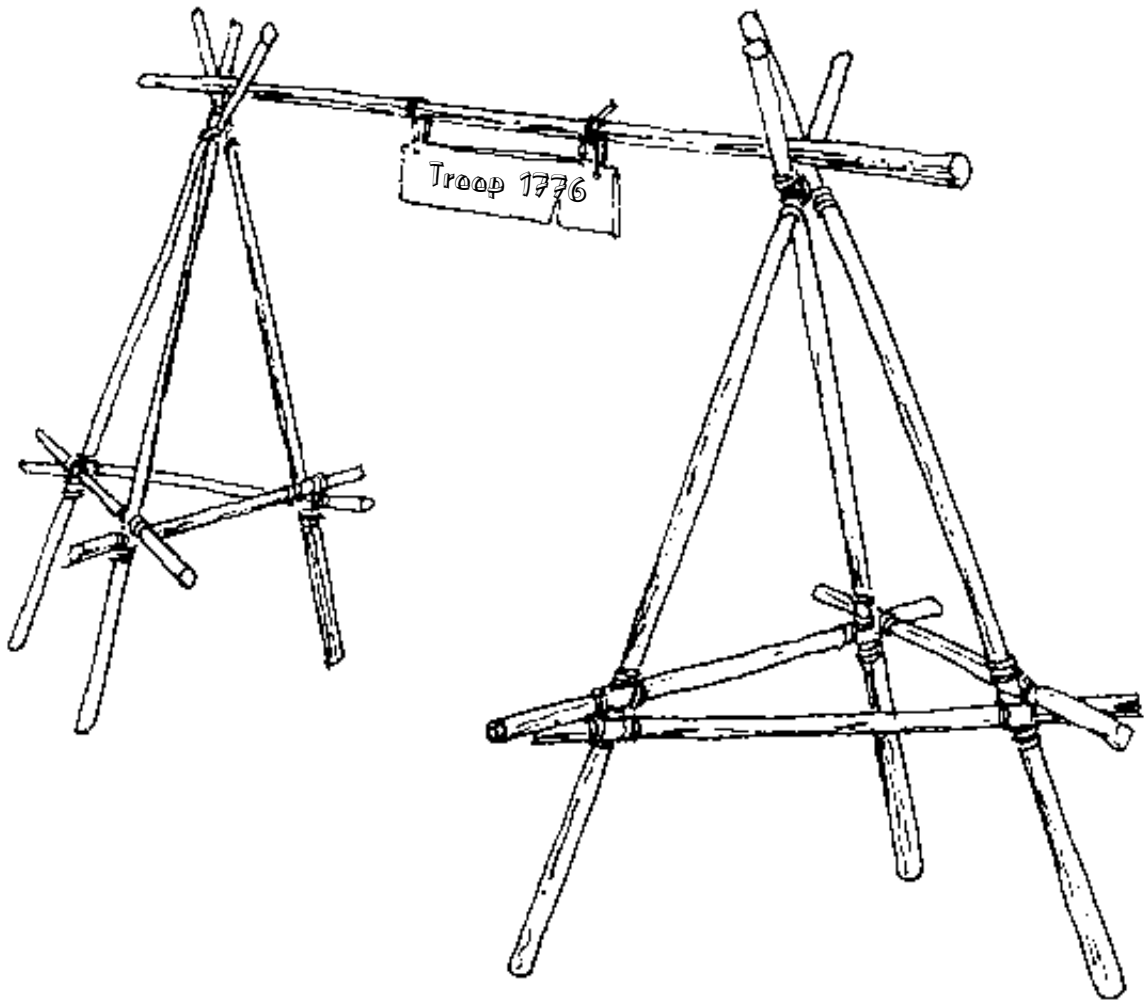
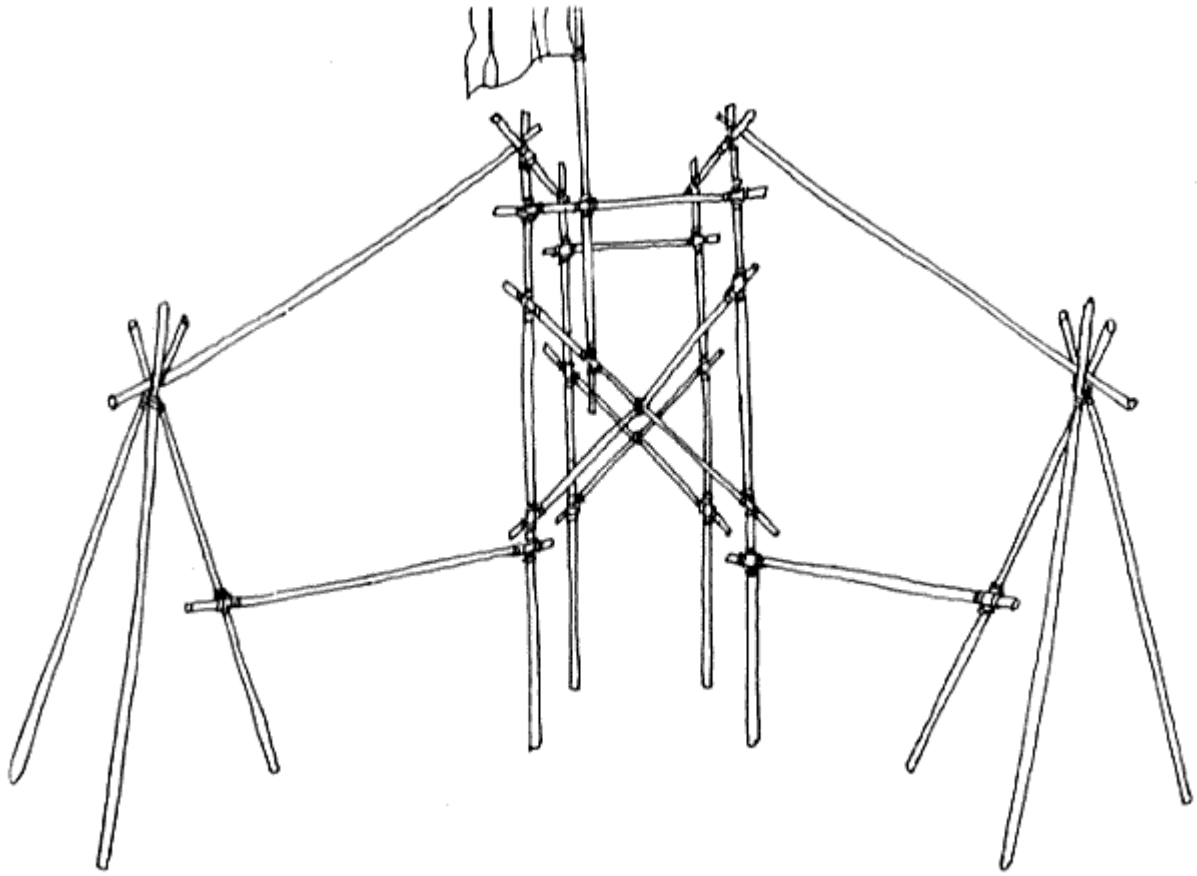

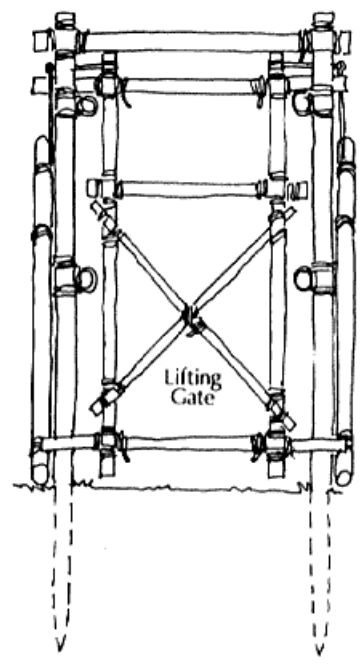
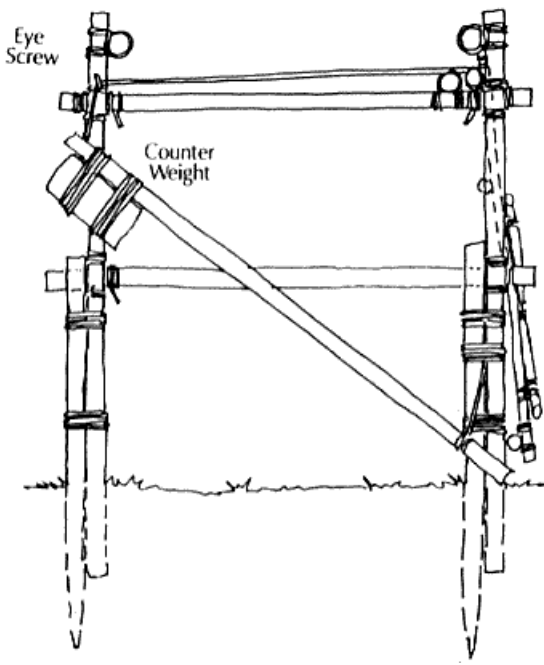
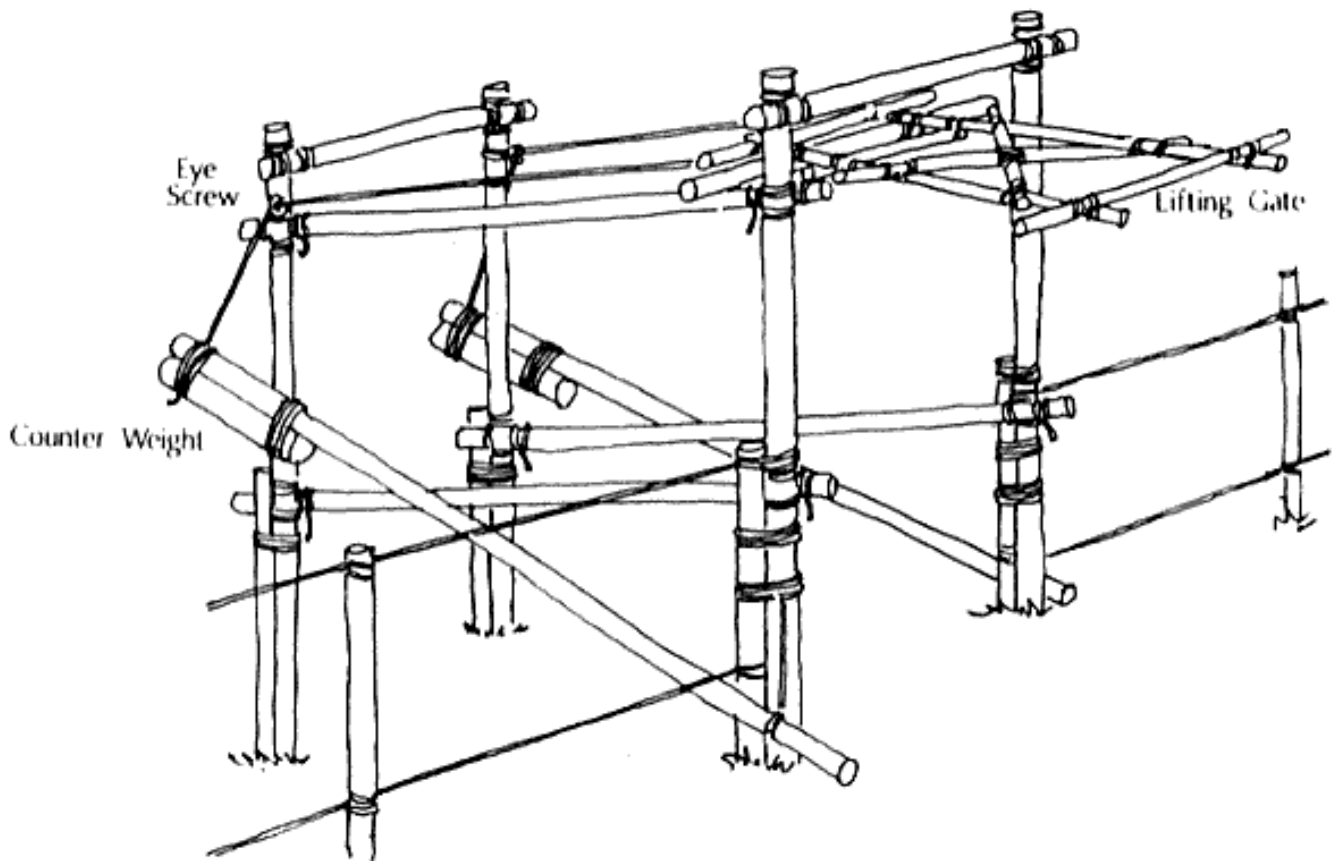

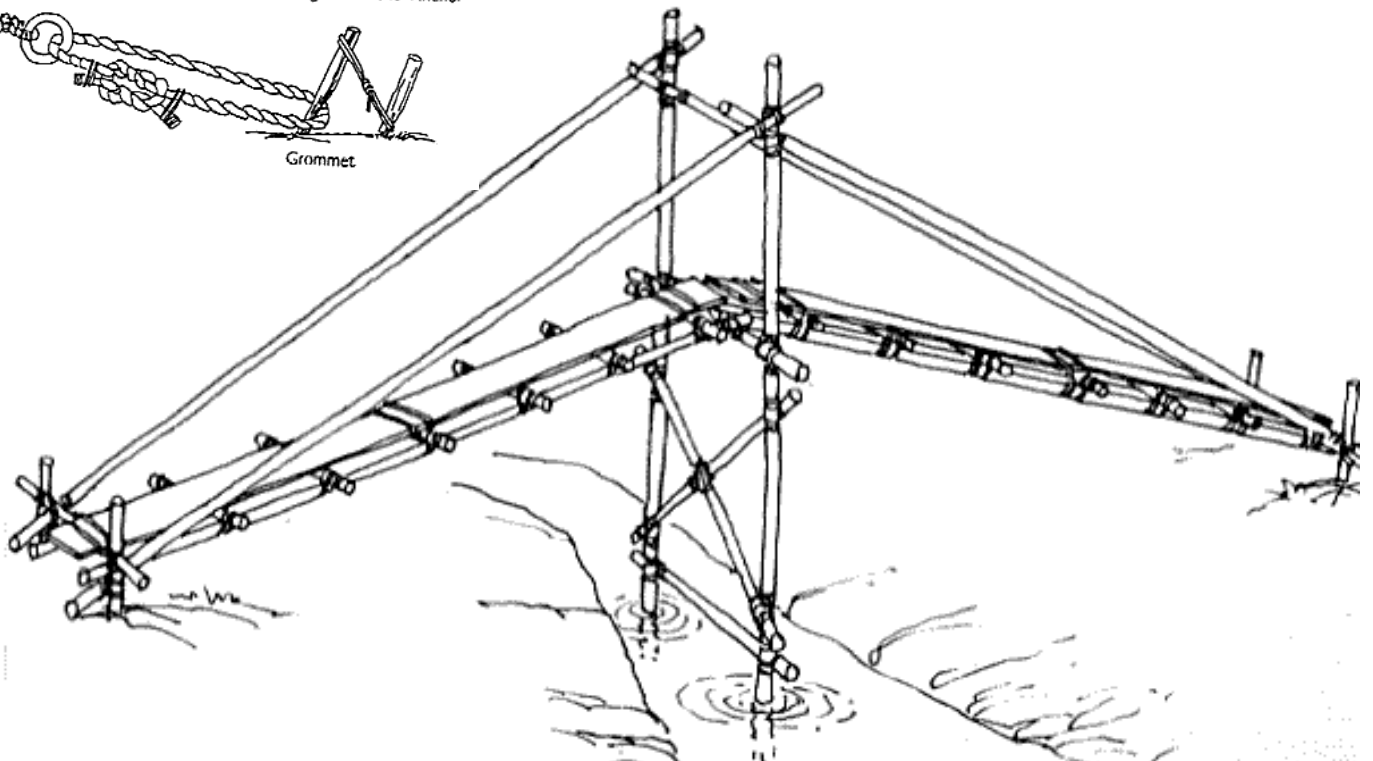
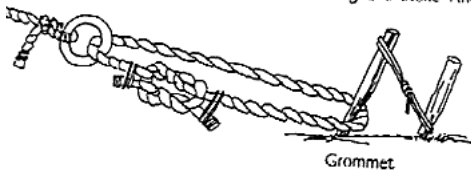
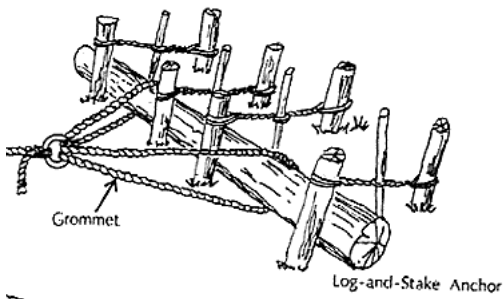
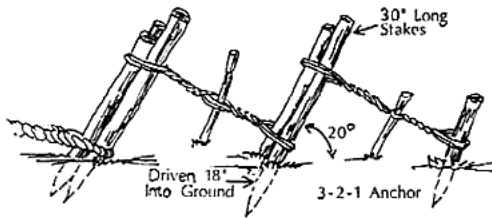
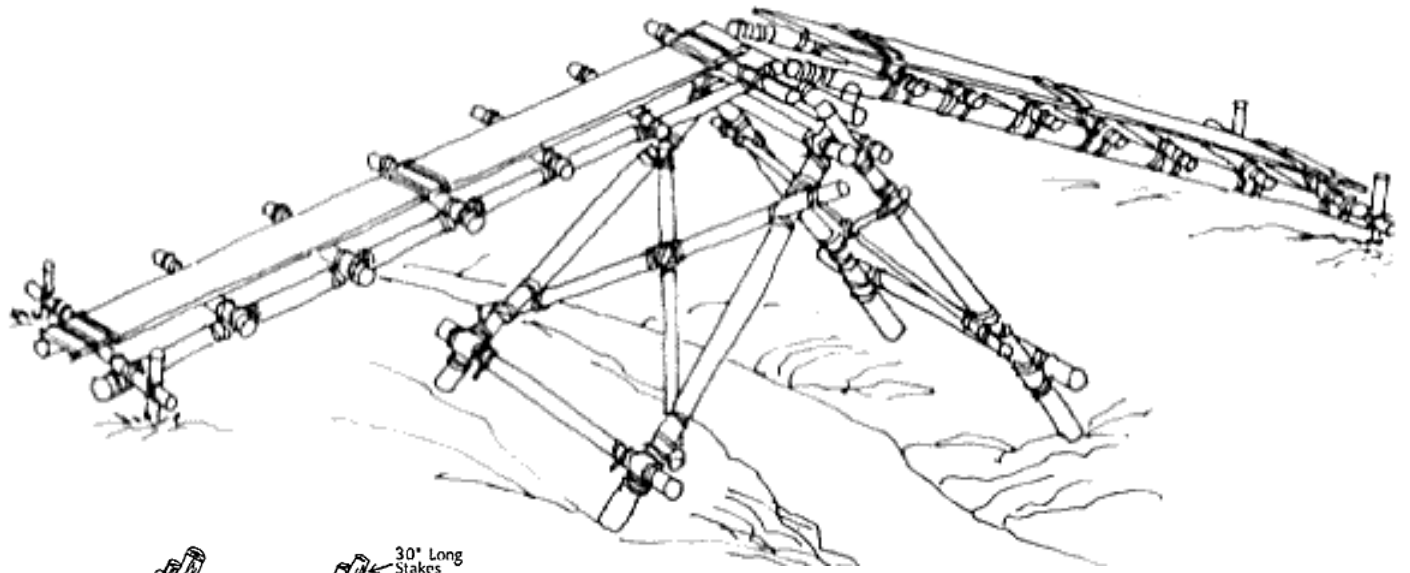

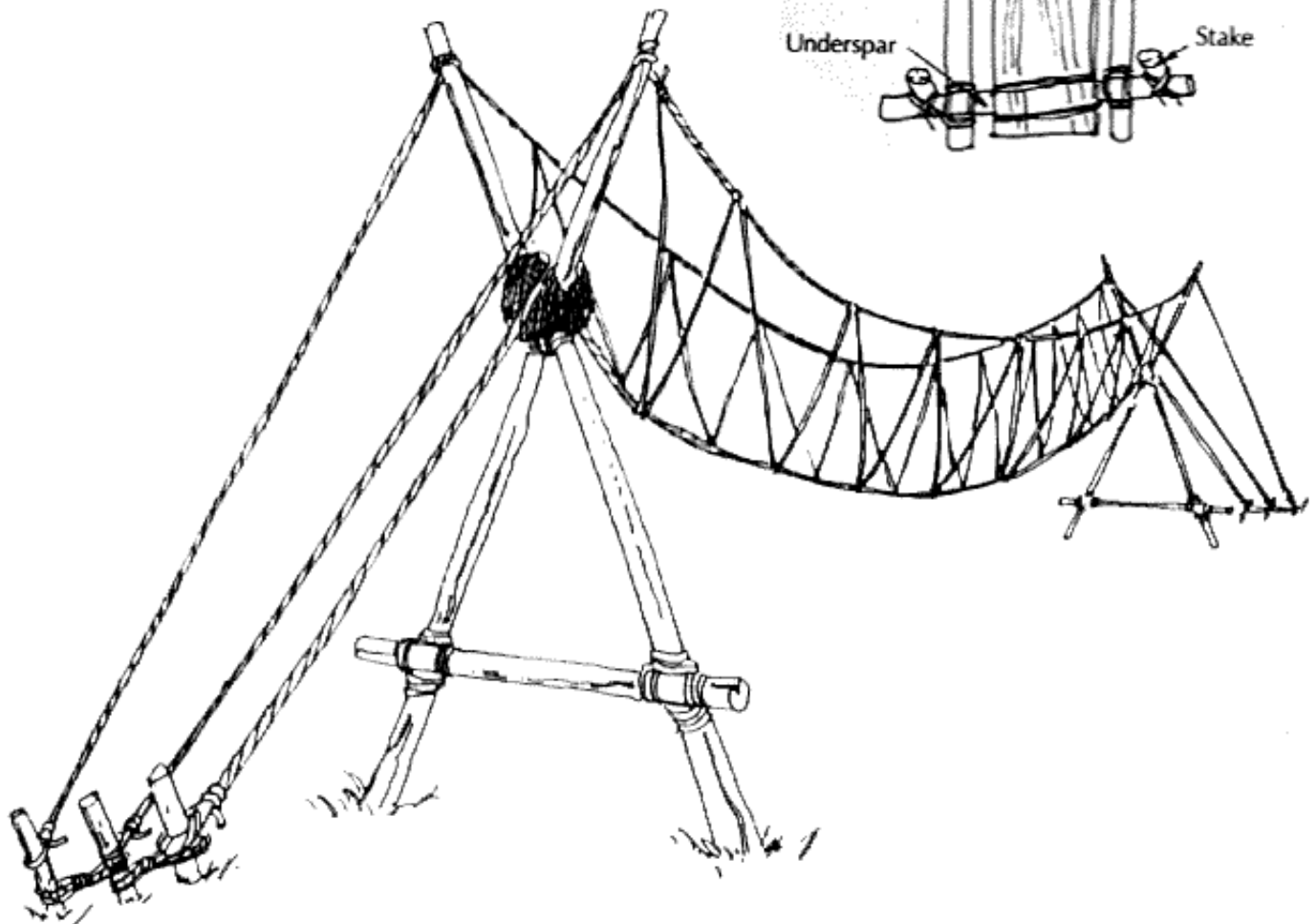
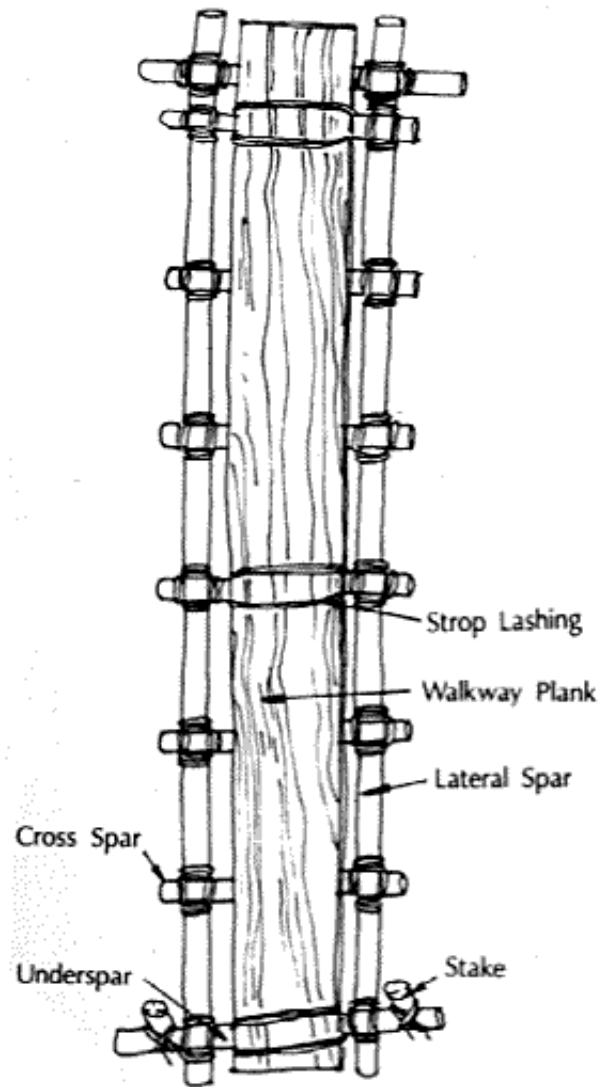
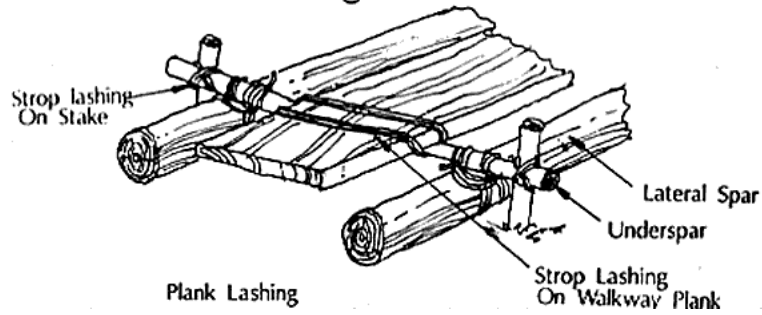
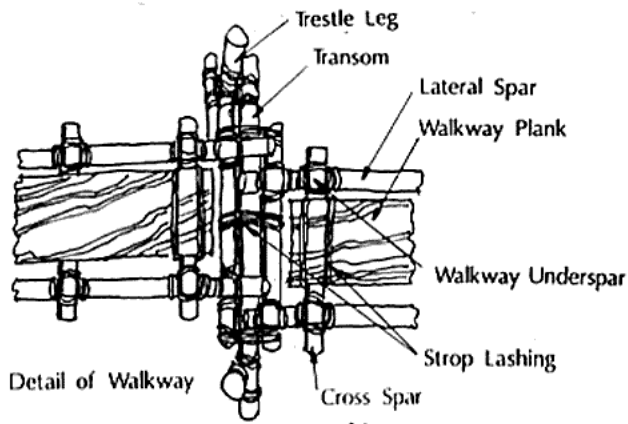

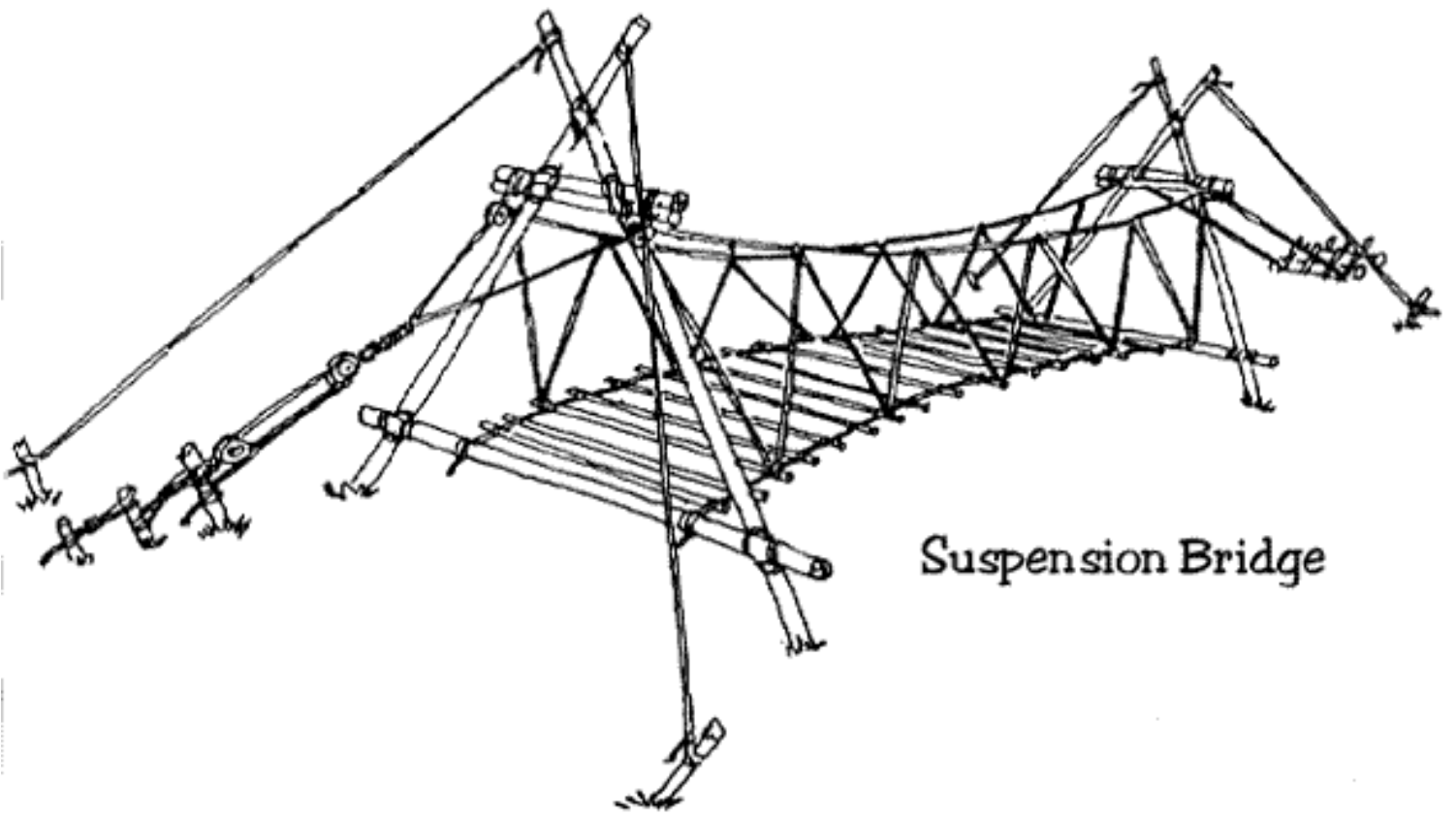

Suspension Bridge

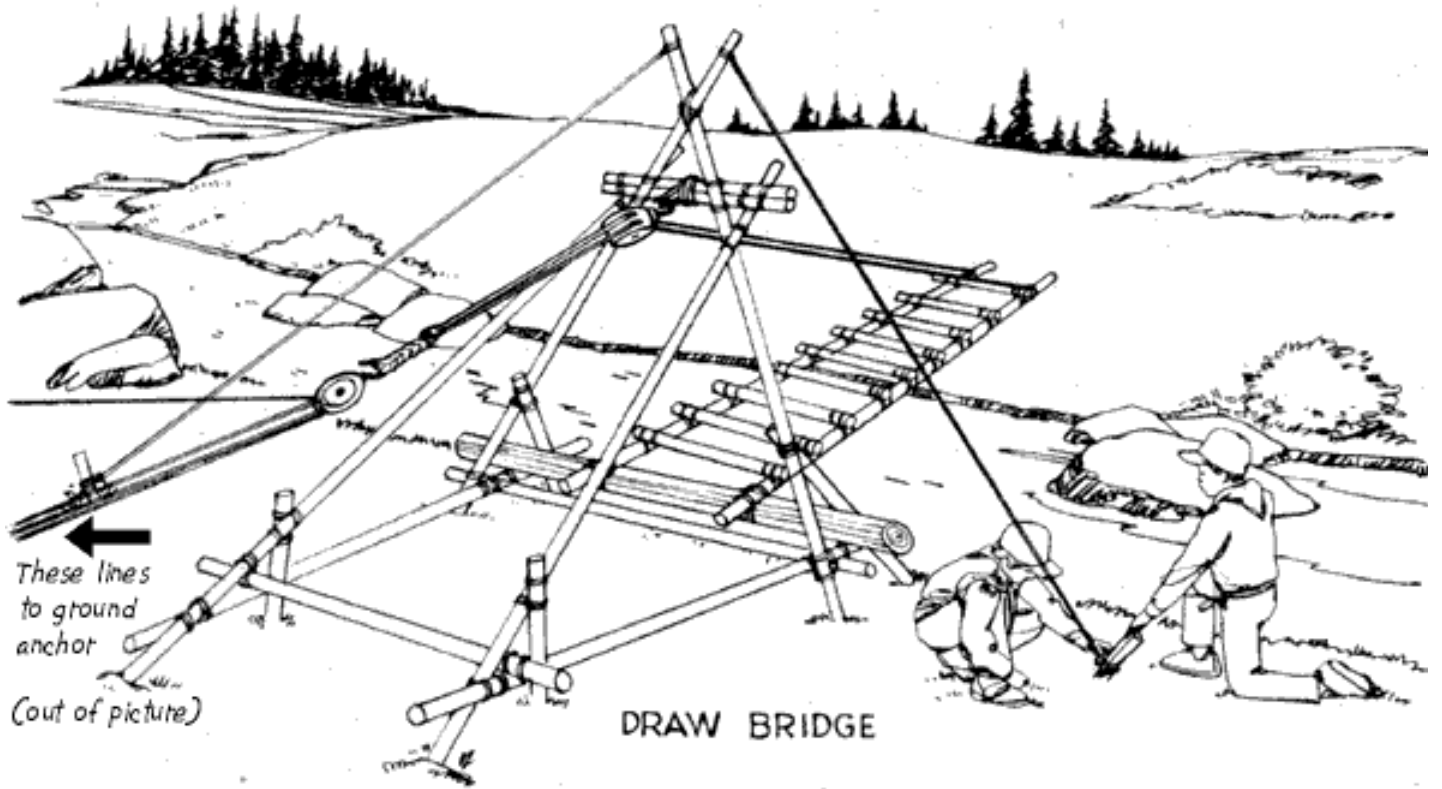

DRAW BRIDGE

Friction Bridge

(note the "rather simple" lashings)

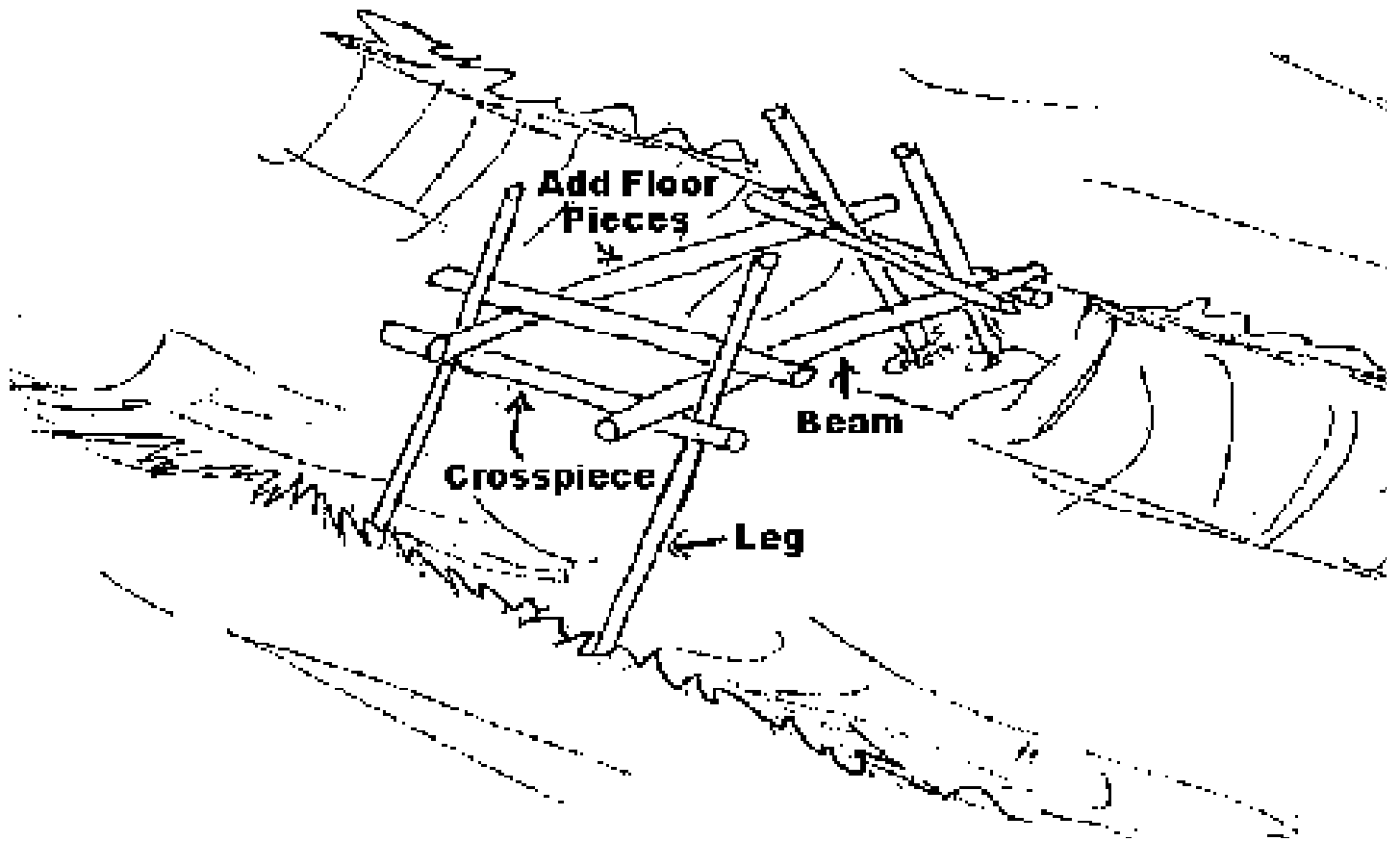

Troop 4's Friction Bridge
<http://www.foothill.net/BSA/troop4>

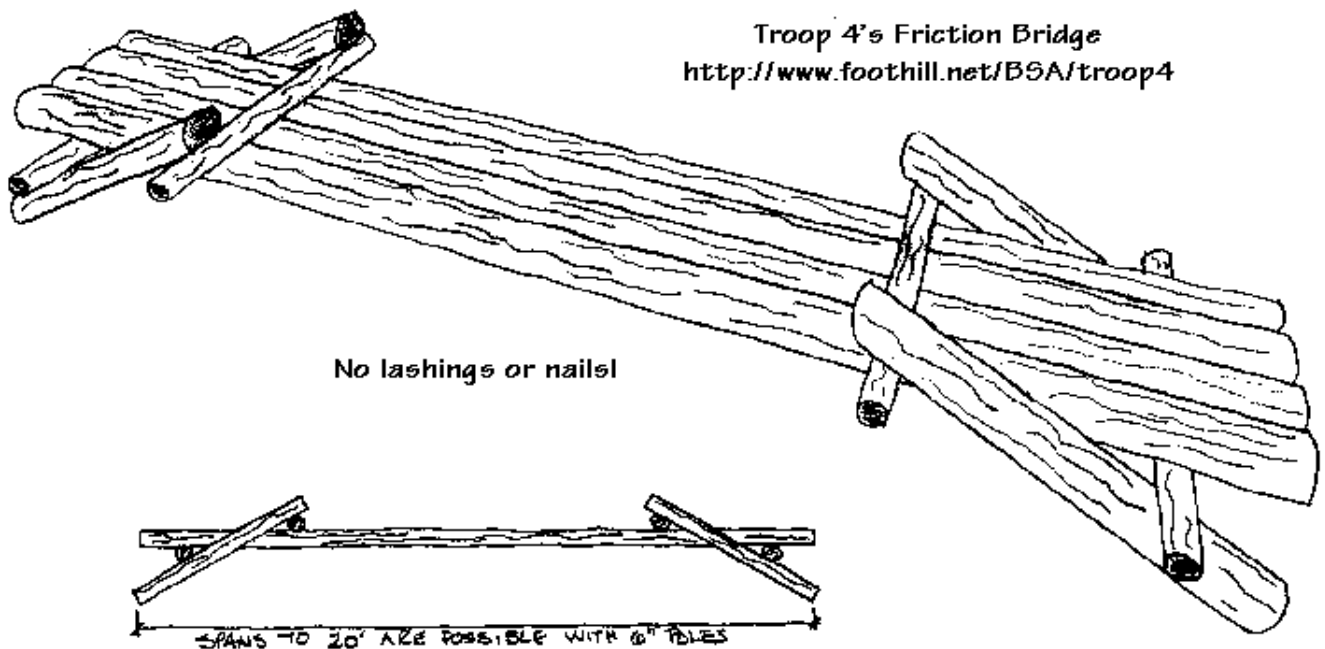

No lashings or nails!

TROOP 18'S
DRAW BRIDGE

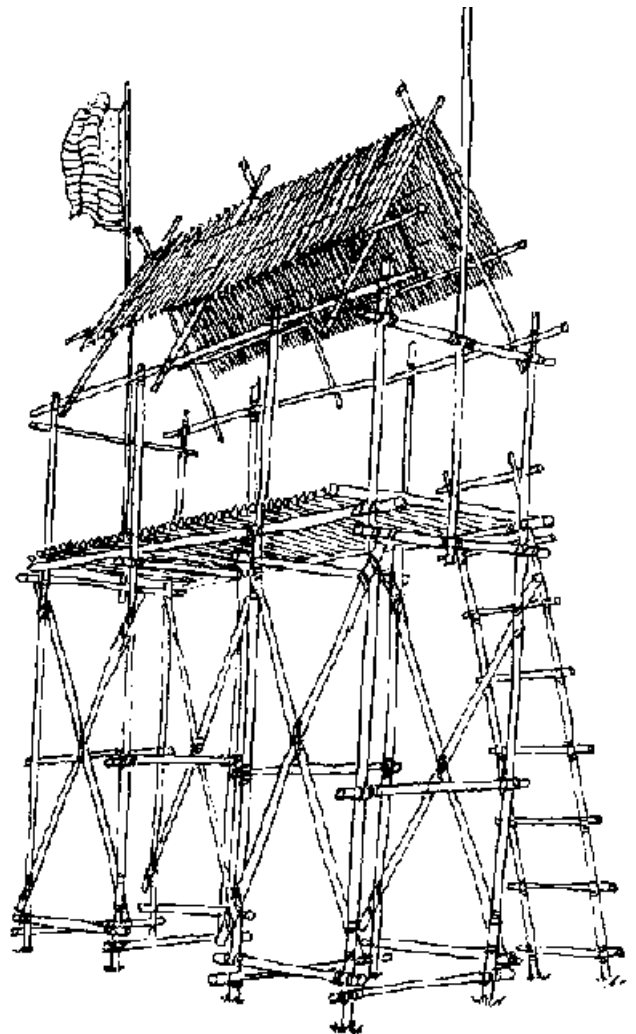
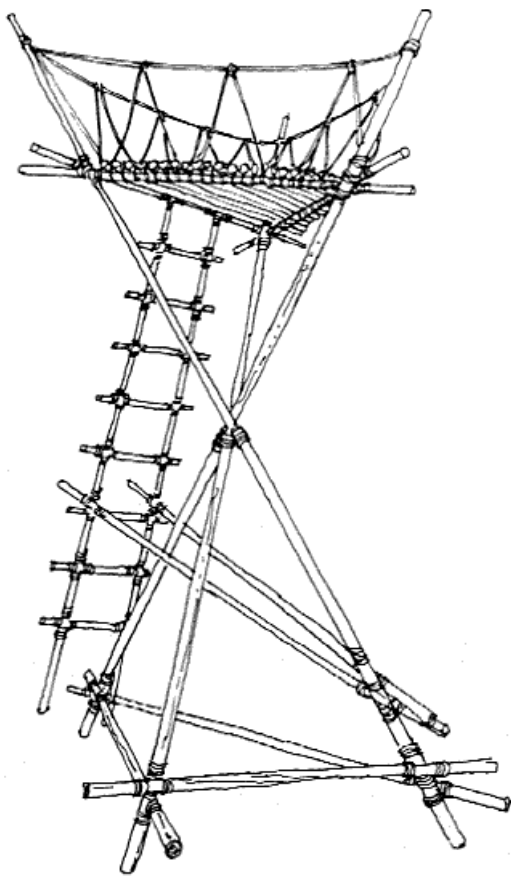
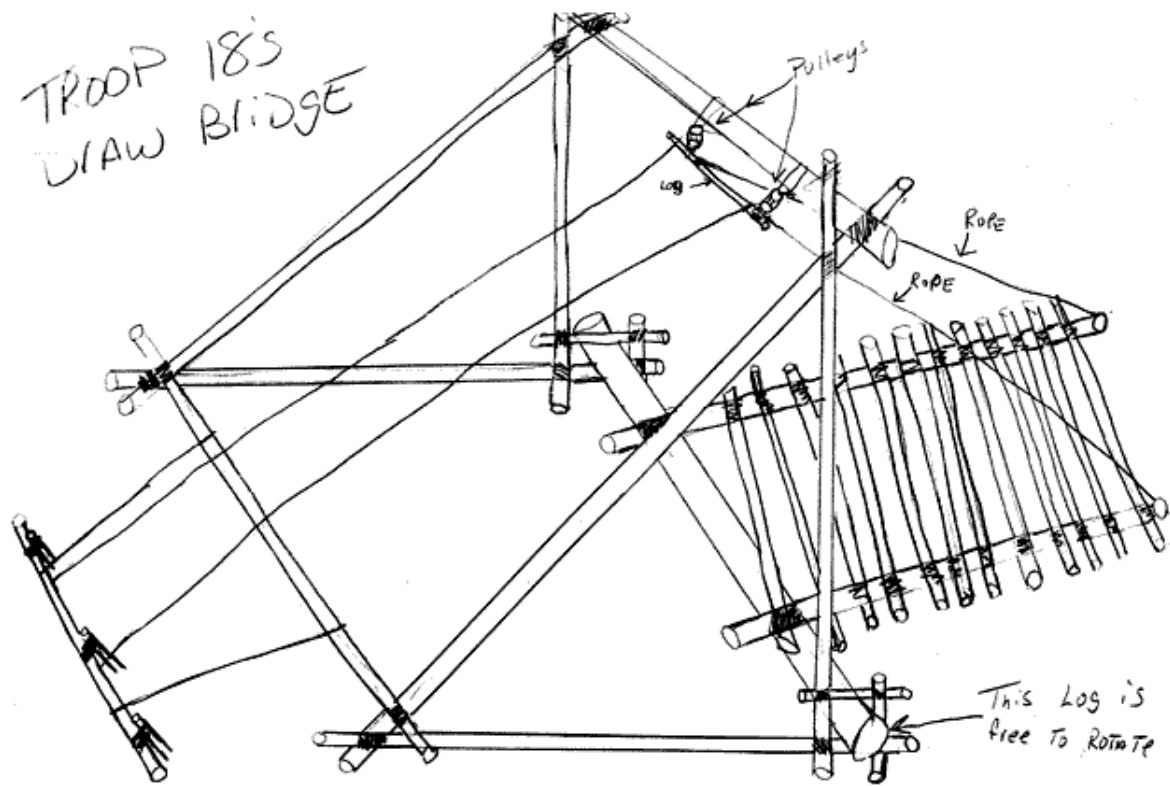

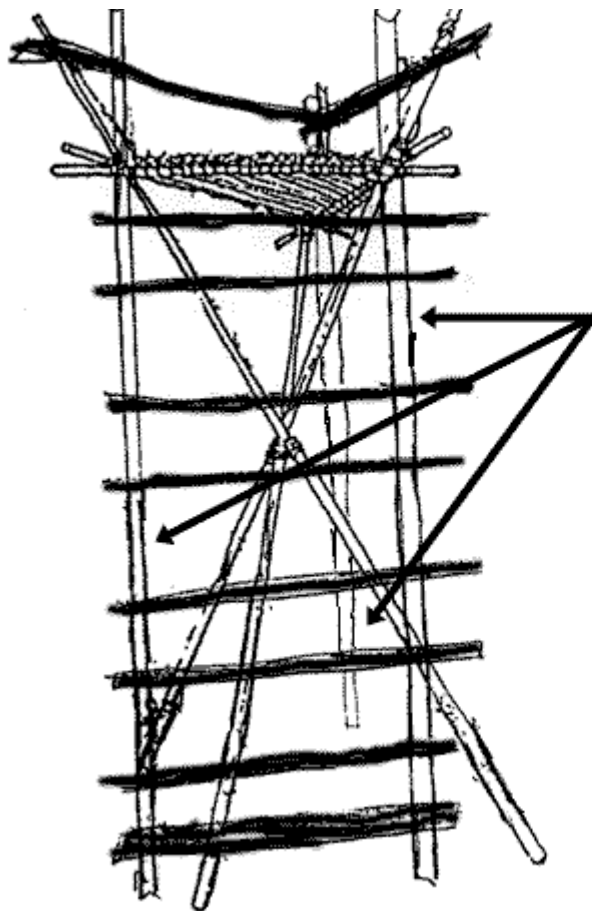
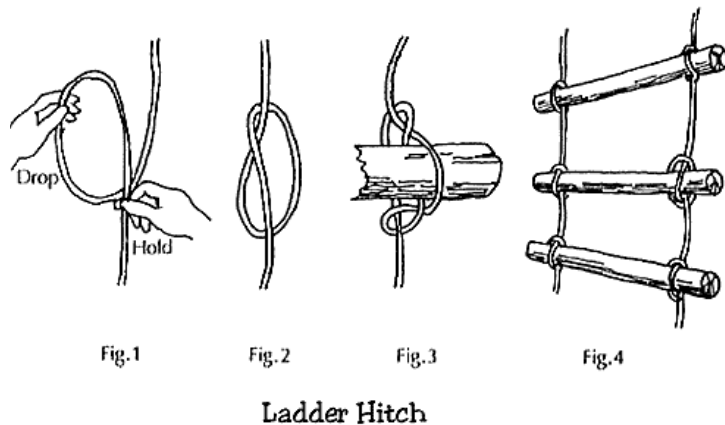
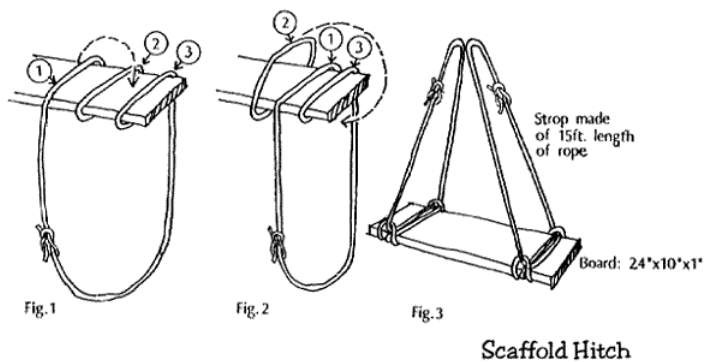
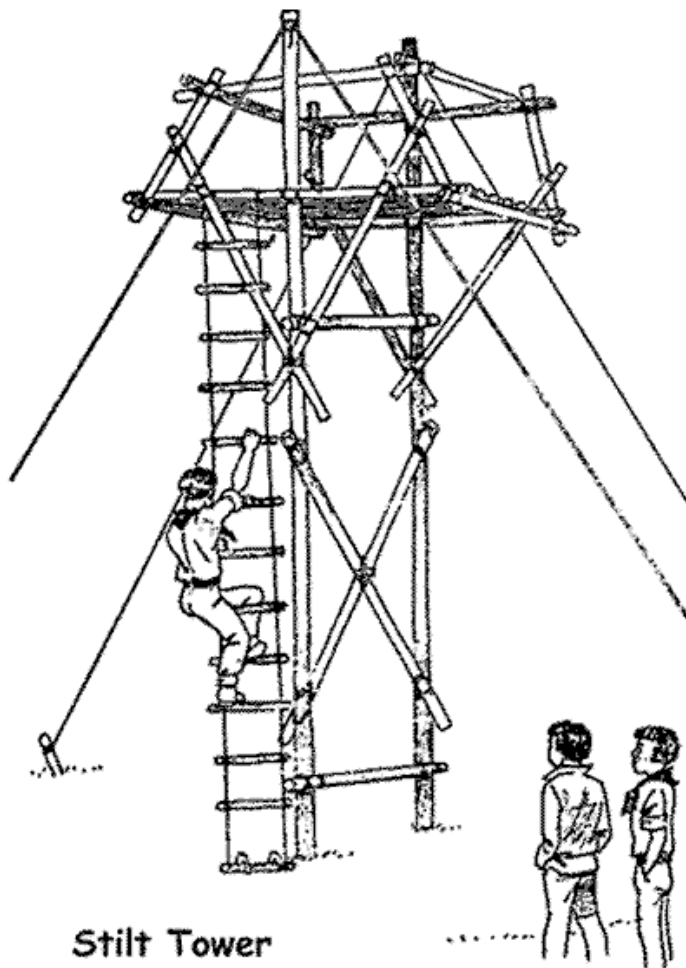

**Wood Badge SC455
"Pfox Tower"**

Includes 3 straight supports that hold the ladder and provide extra bracing. You may or may not need these. AS BUILT, this tower held 4 200lb. adults at one time!

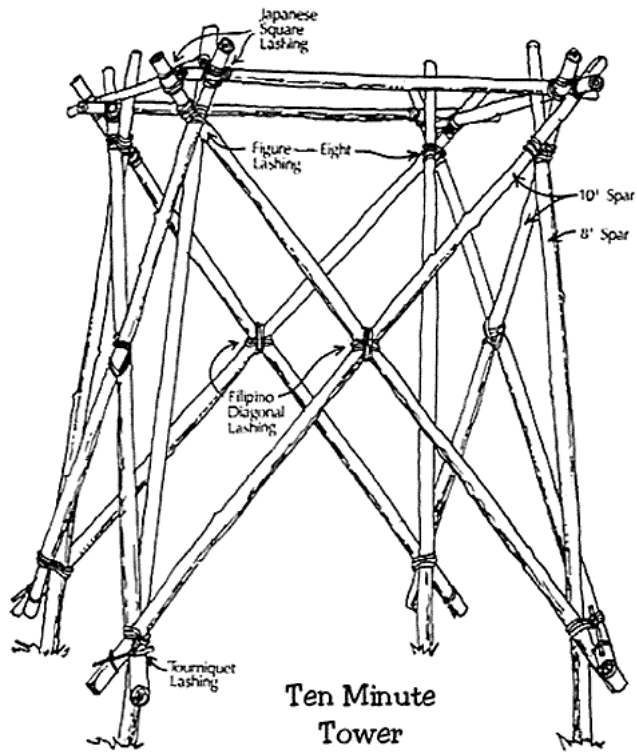
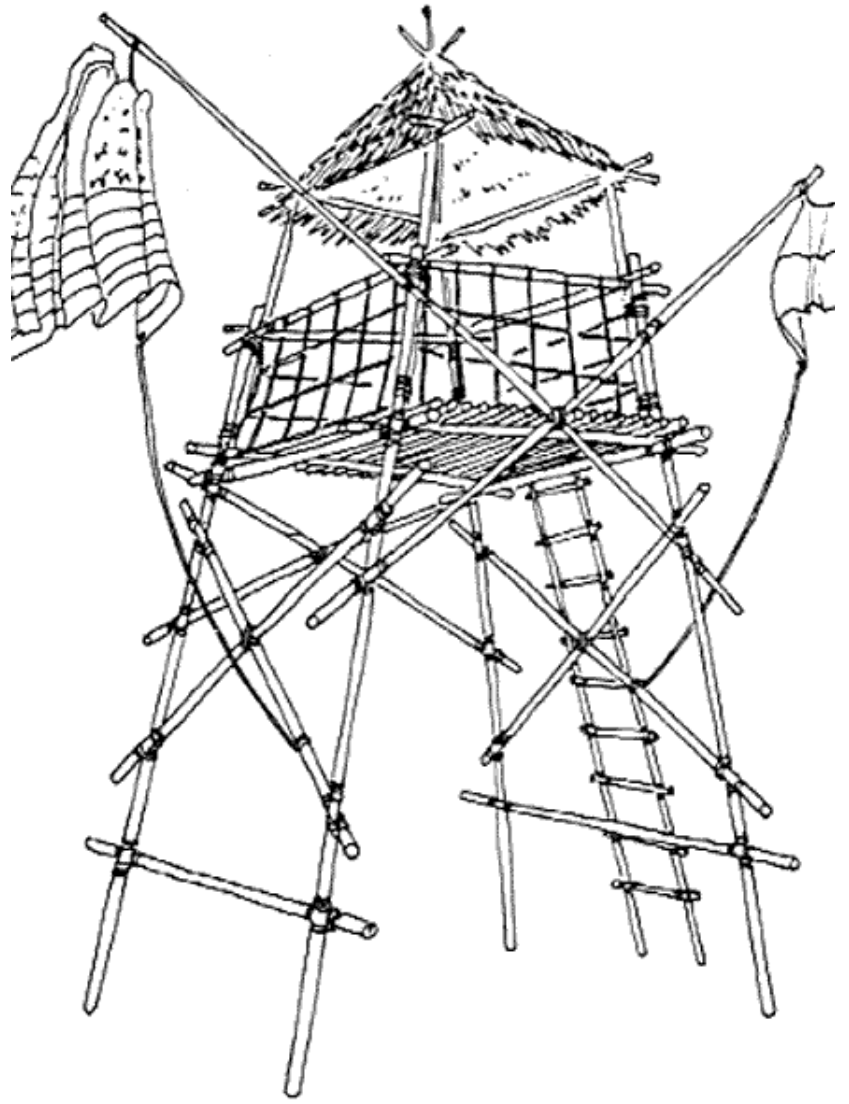
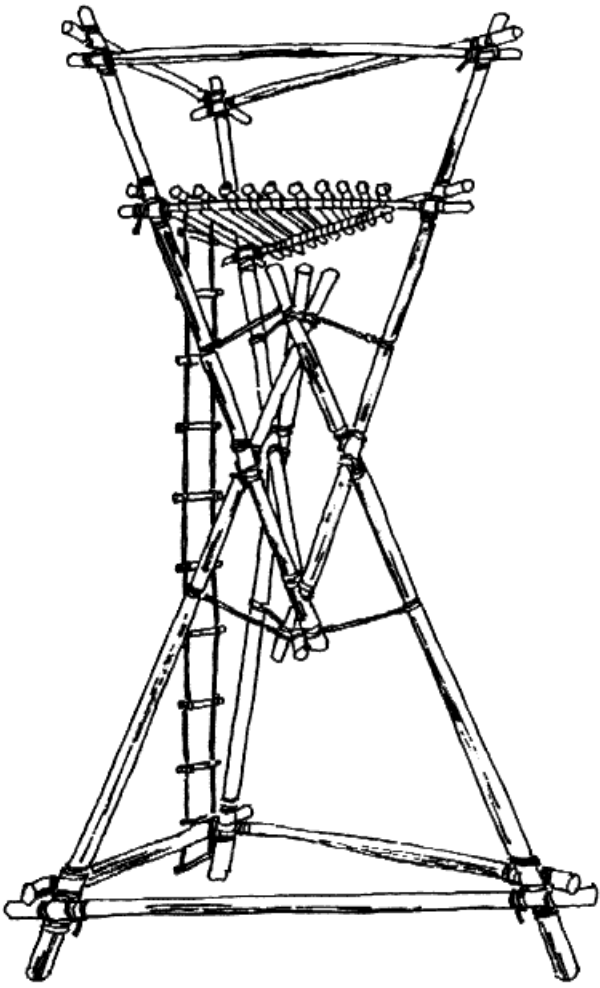

Ten Minute Tower

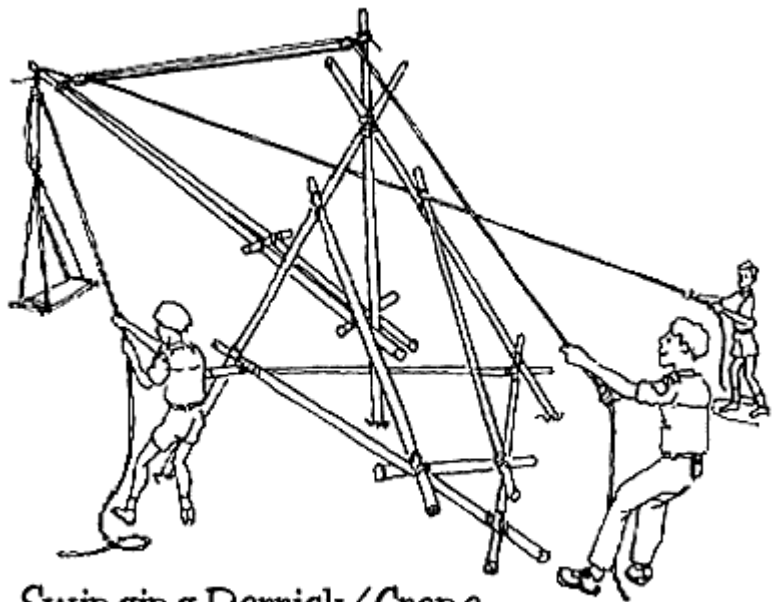

Swinging Derrick/ Crane

Brynbach Tower

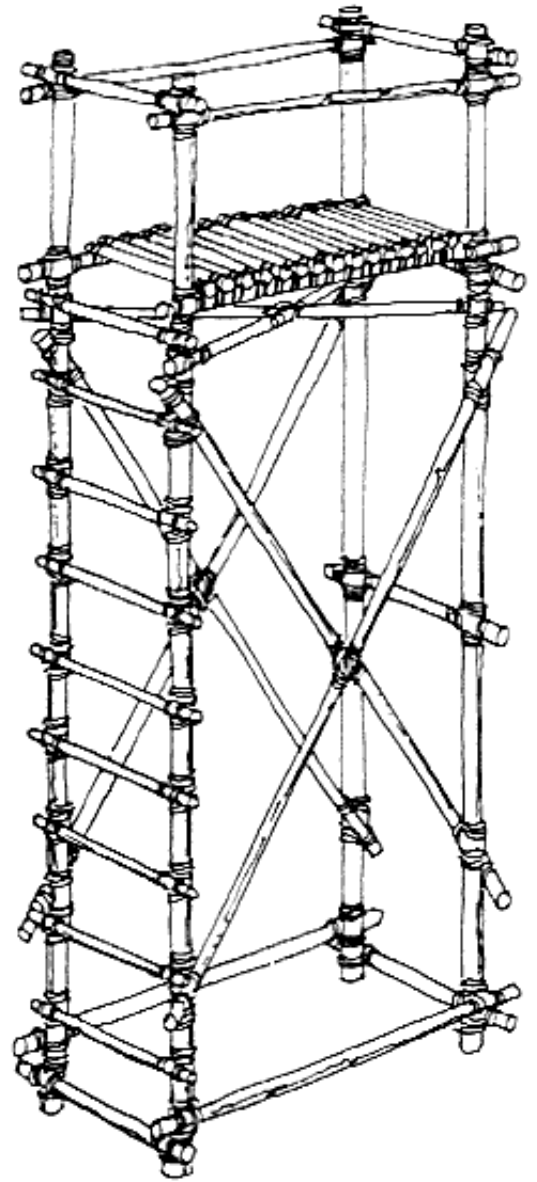
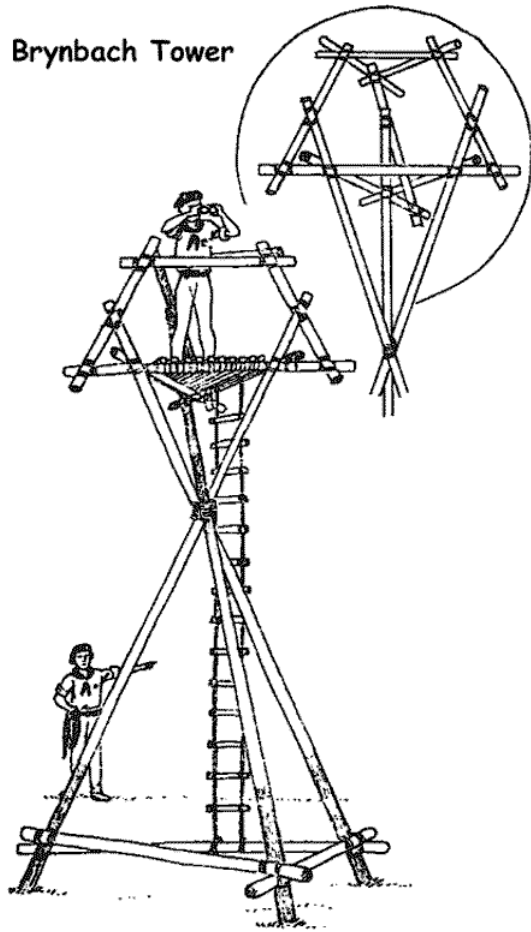

Climbing Wall

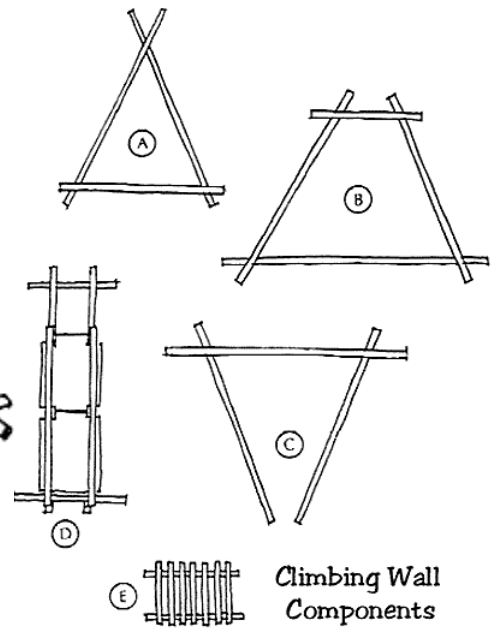
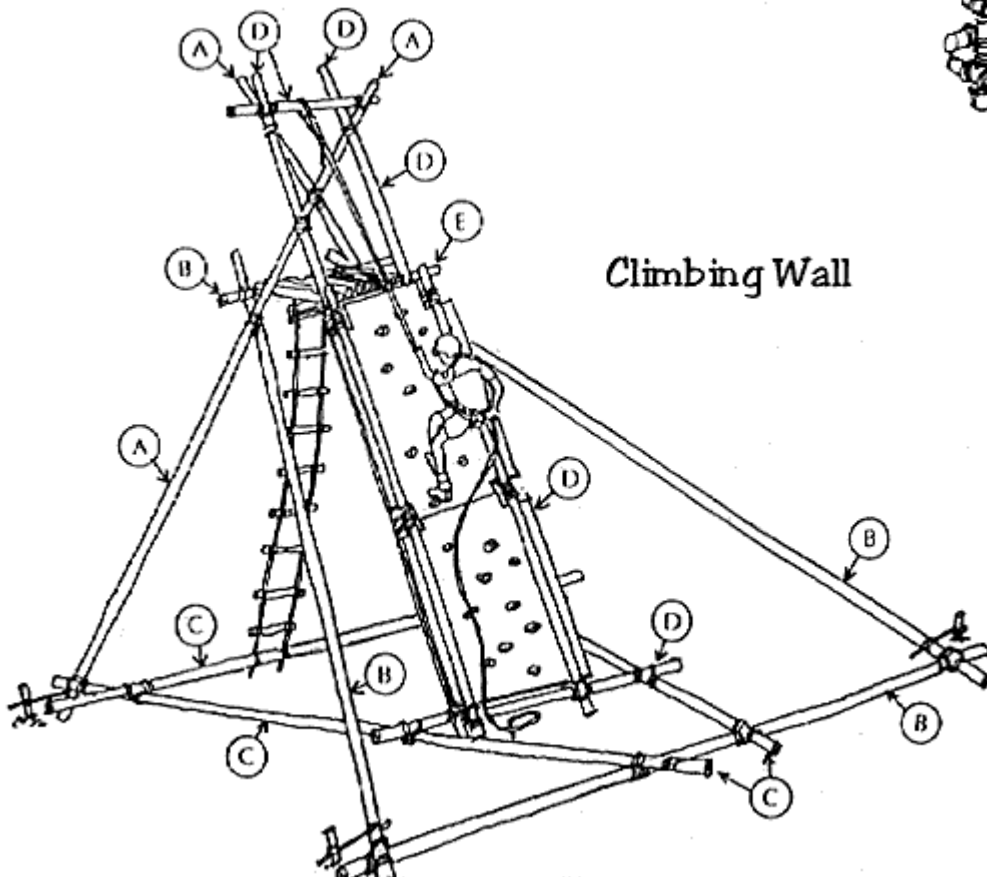

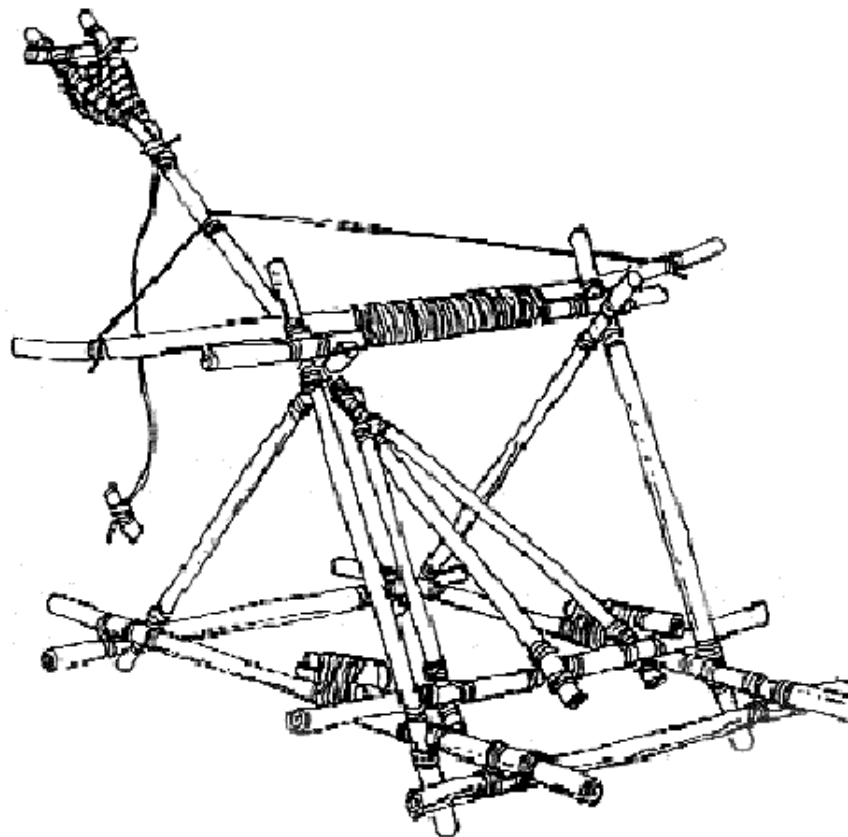
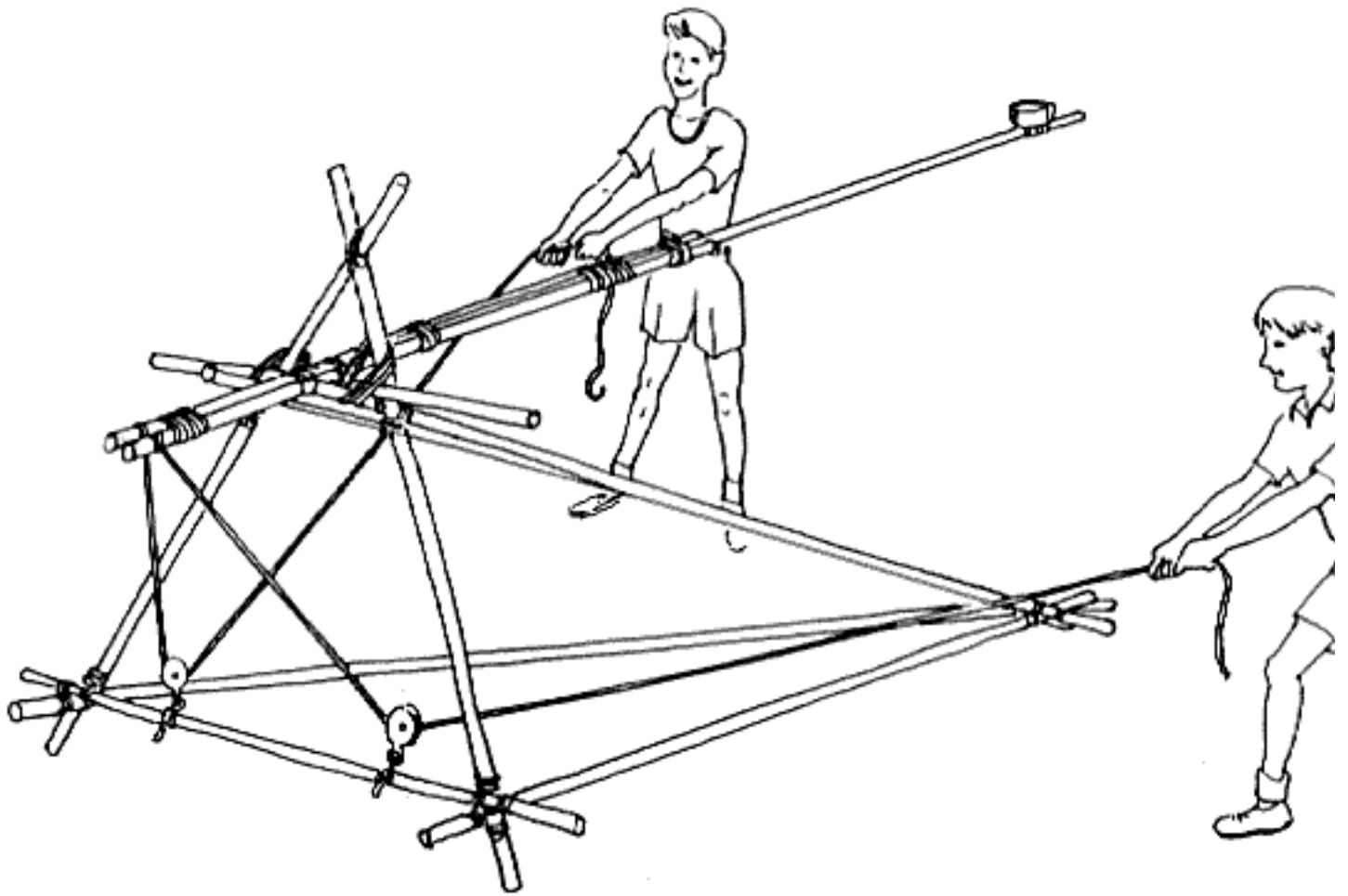

catapult

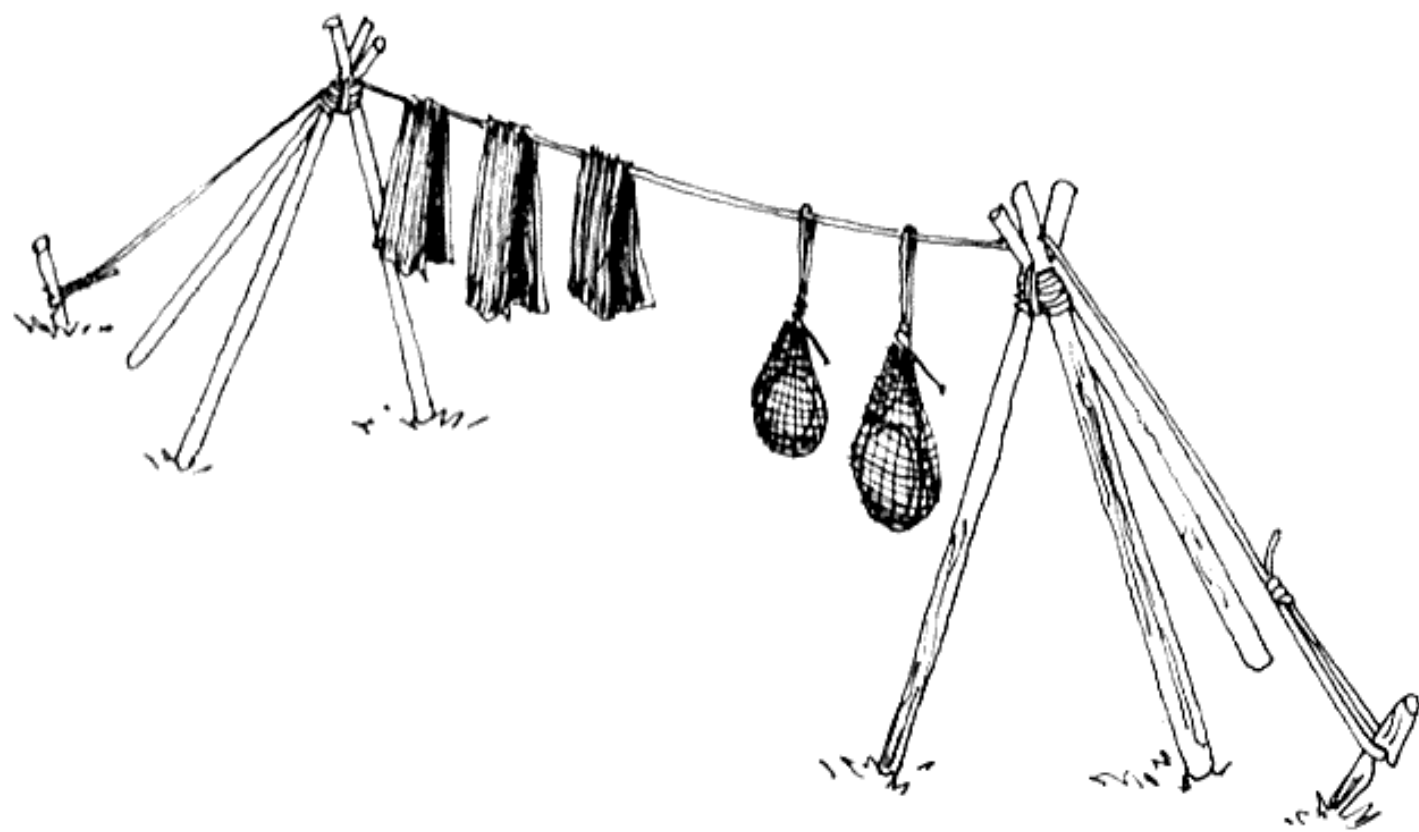
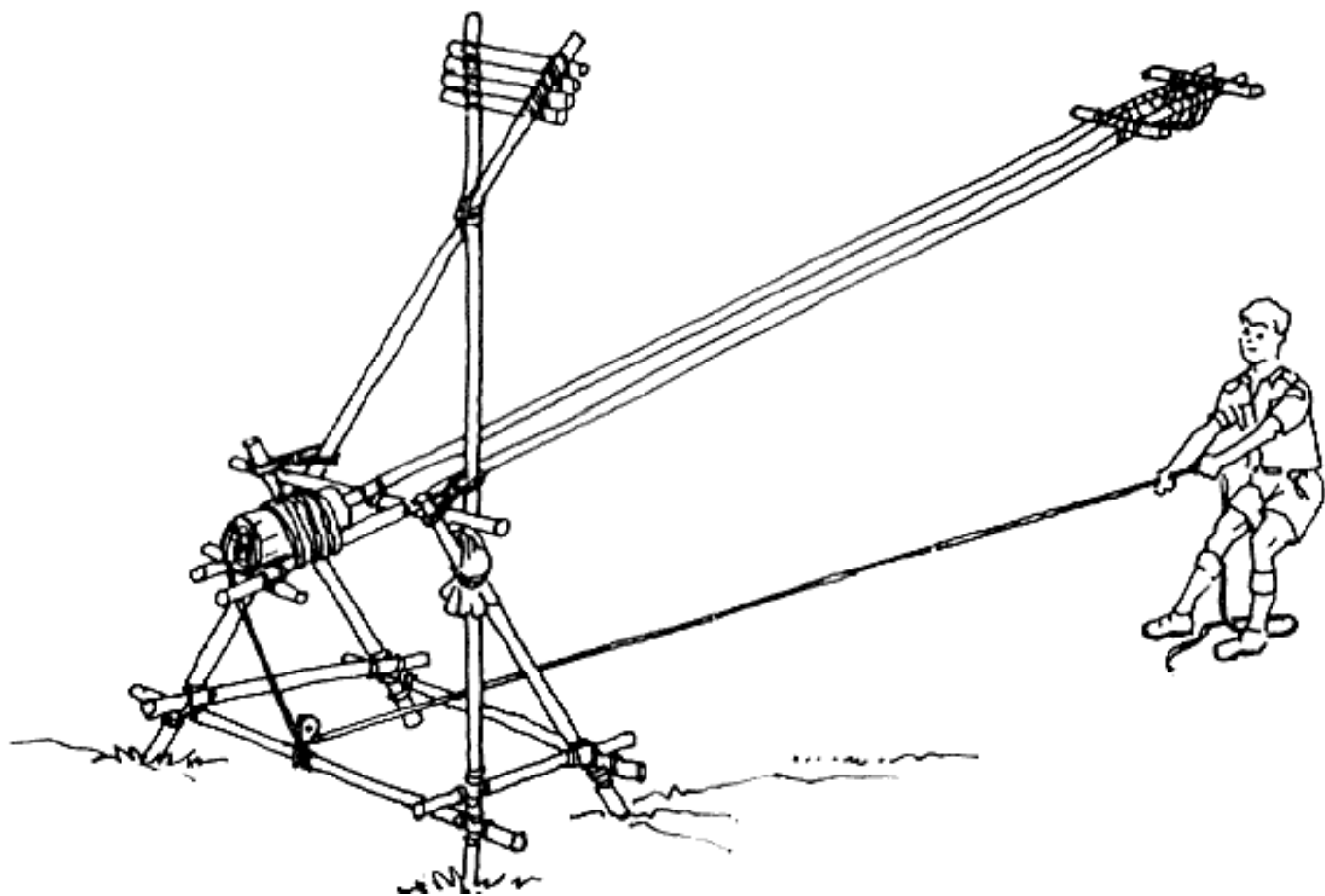

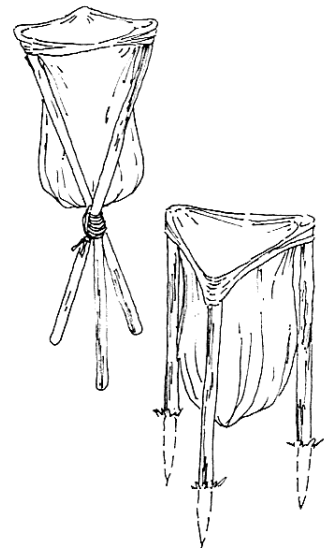
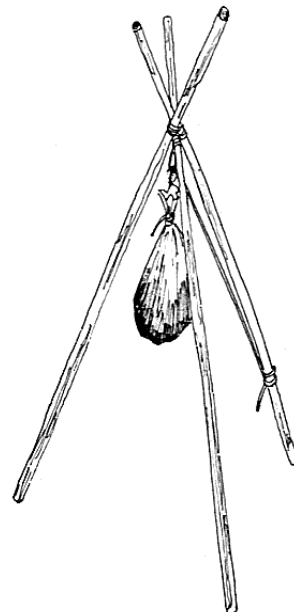
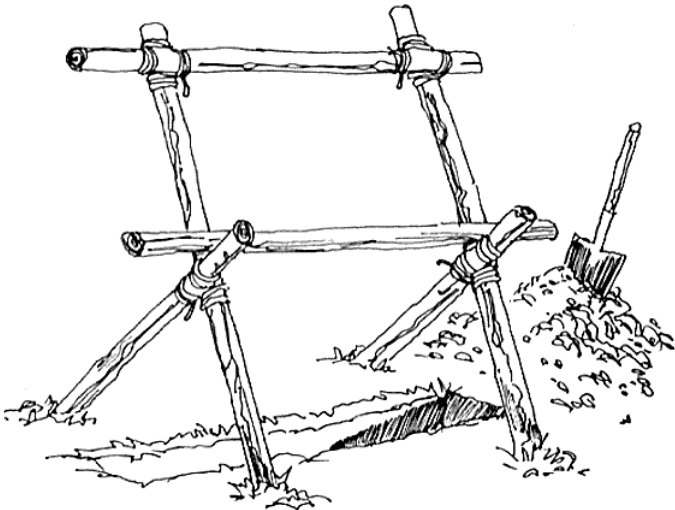
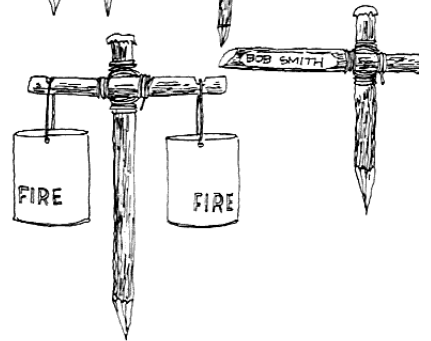
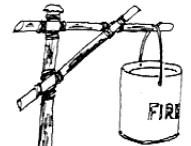
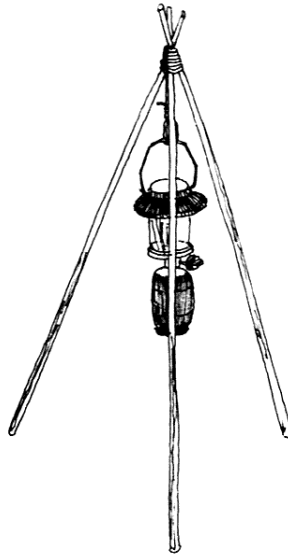
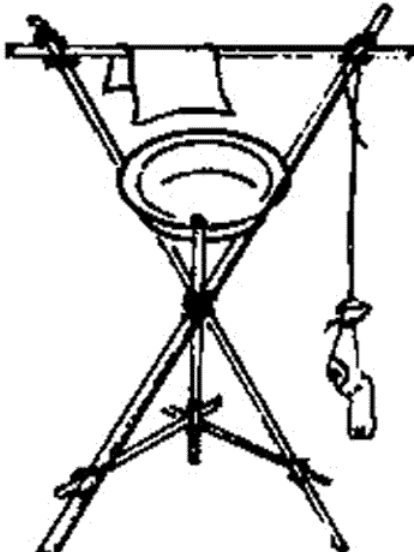
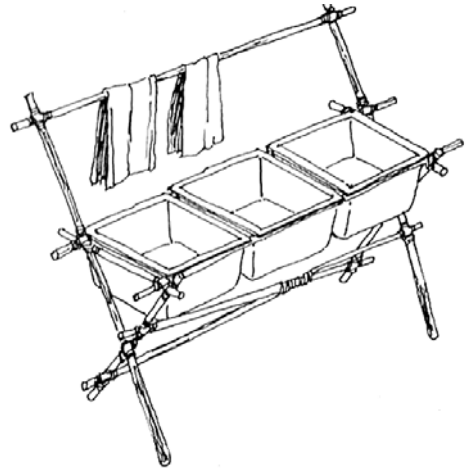
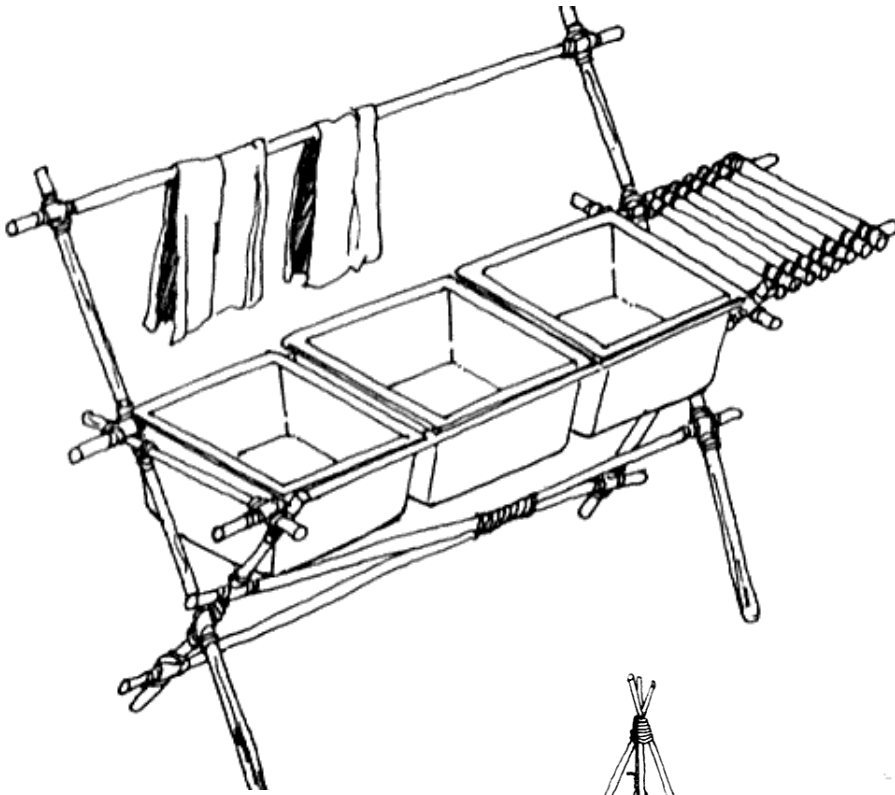

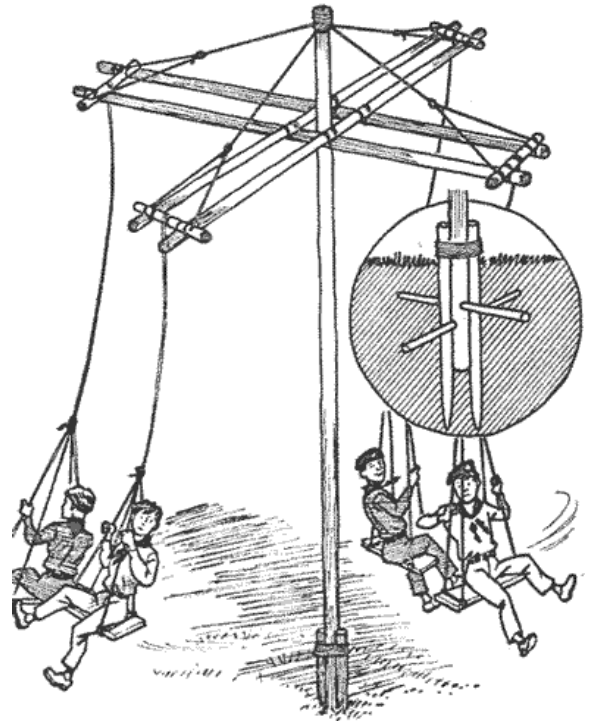
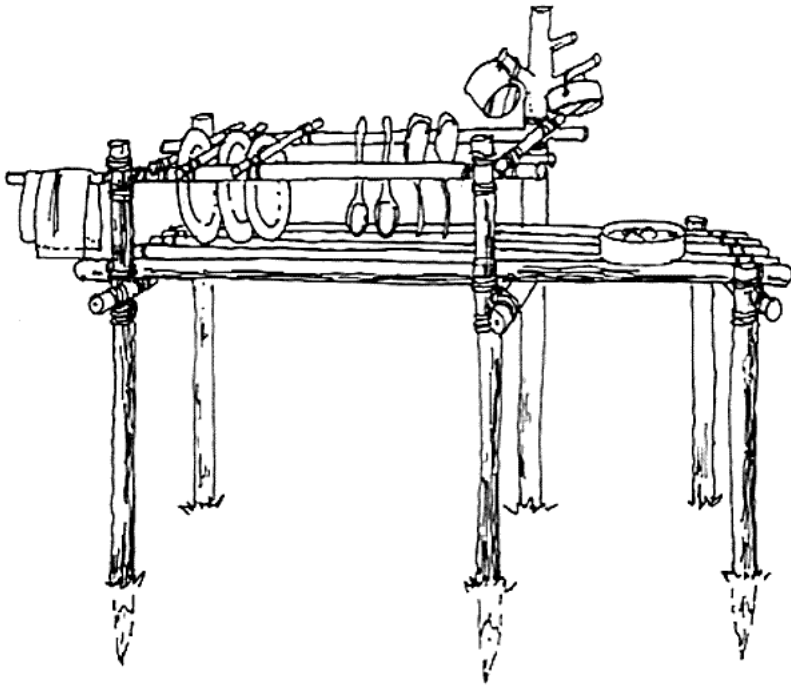

Cambridge Merry-Go-Round

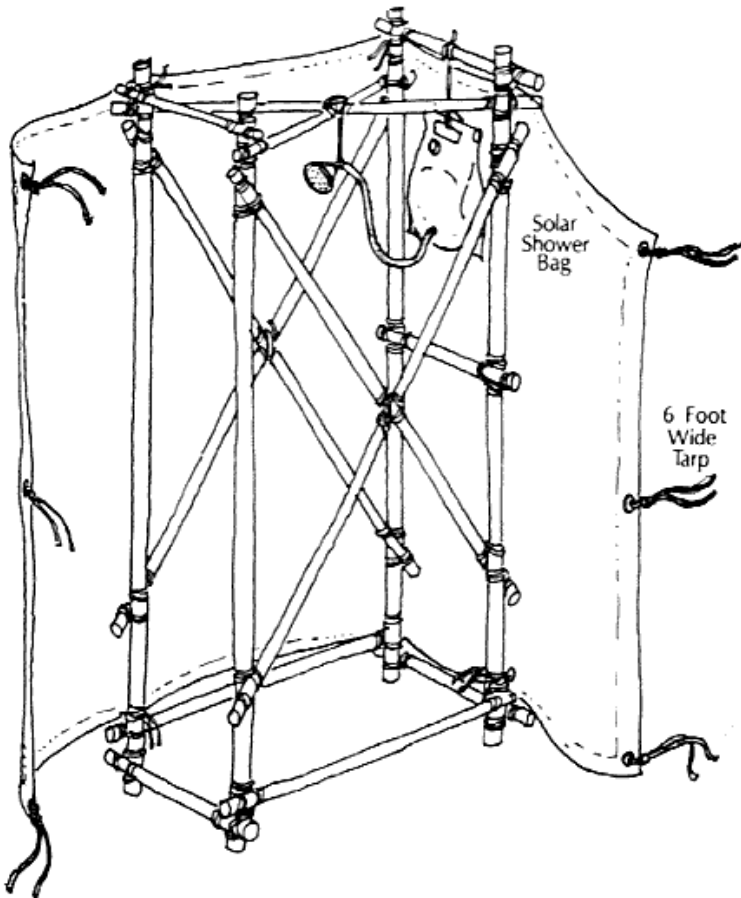

Camp Podium

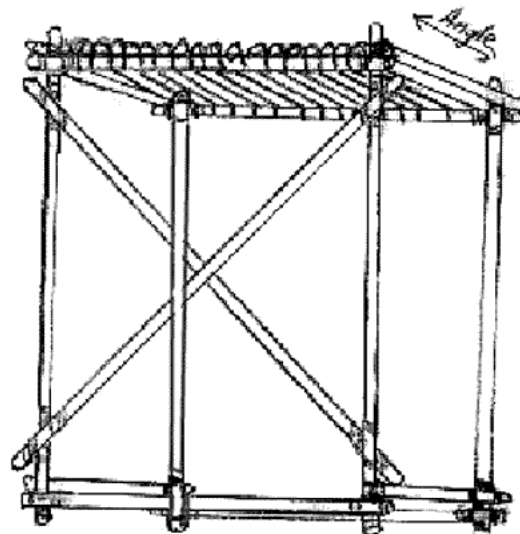

Ducking Stool

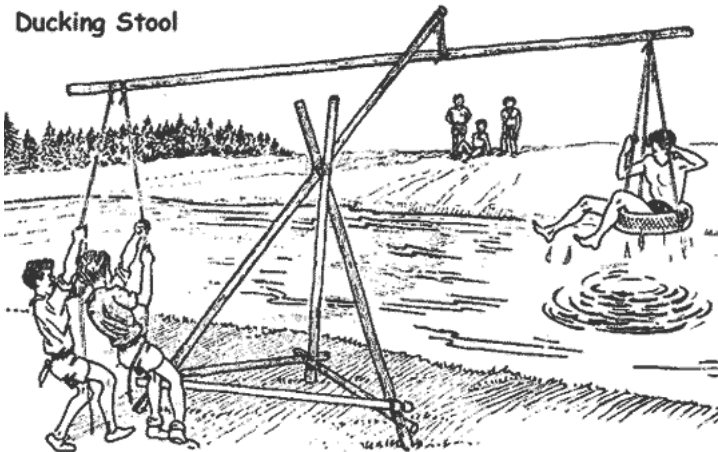

Wash Basin

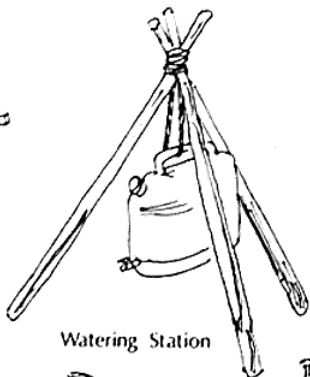

Watering Station

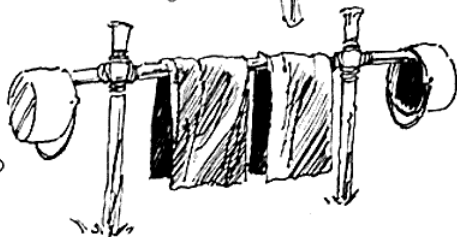

Towel Rack

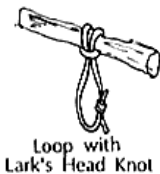
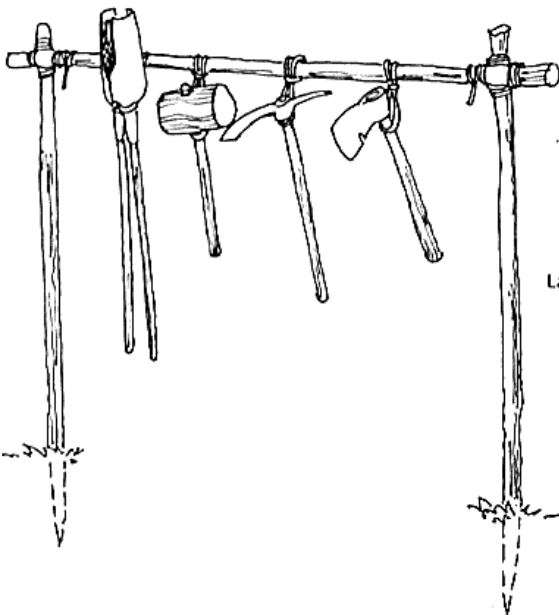

Loop with Lark's Head Knot

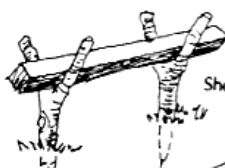

Shoe Scraper

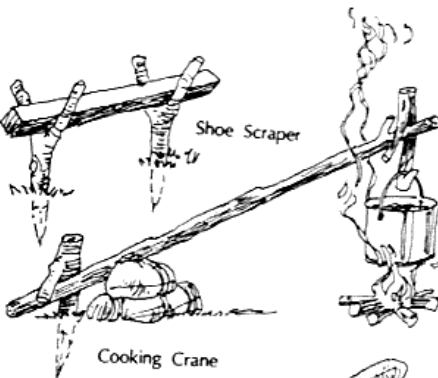

Cooking Crane

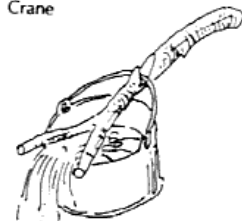

Hot Pot Handle

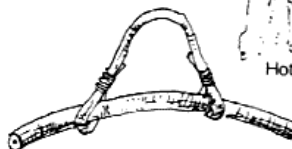

Coat Hanger



Broiler

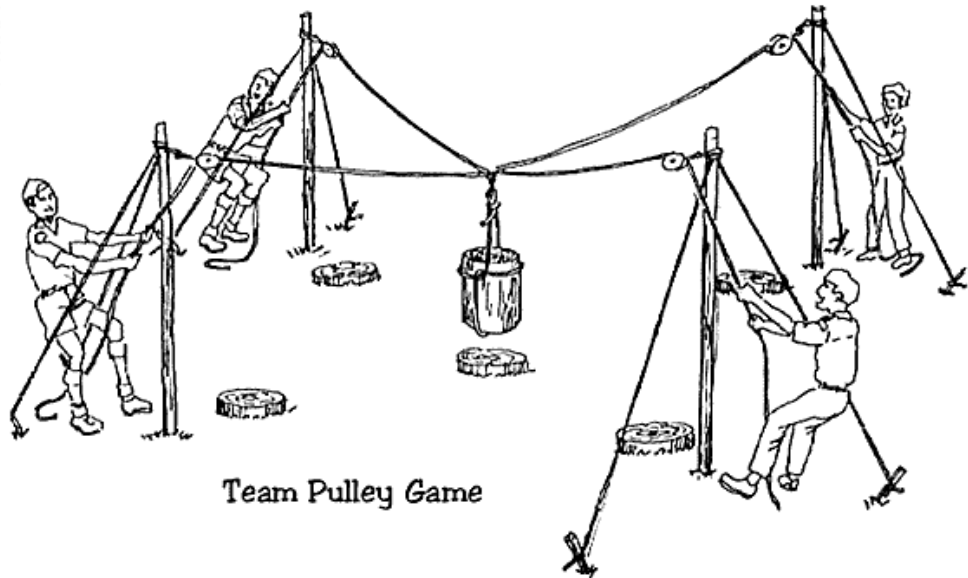

Team Pulley Game

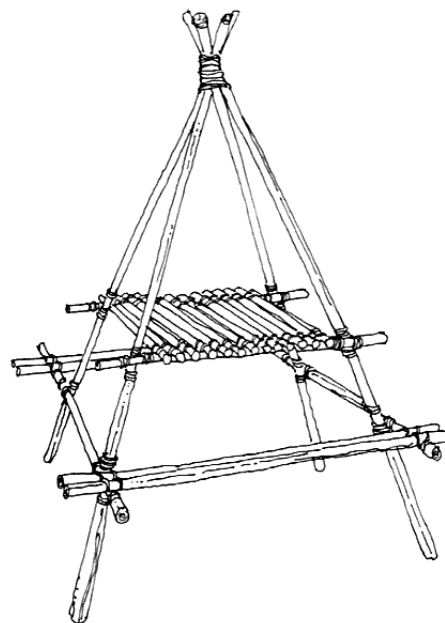
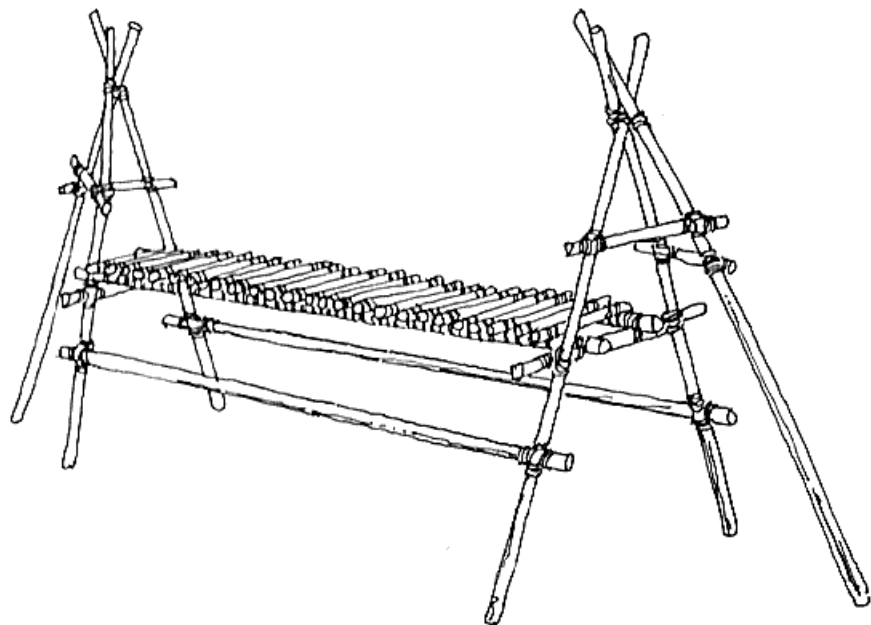
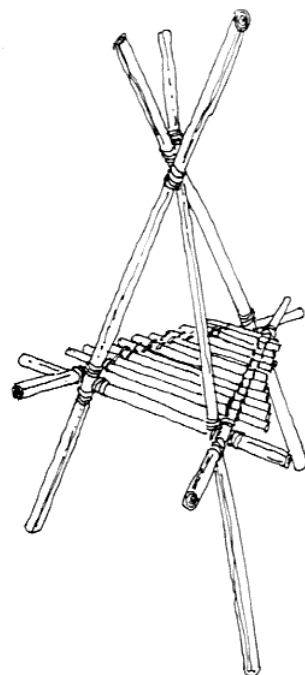
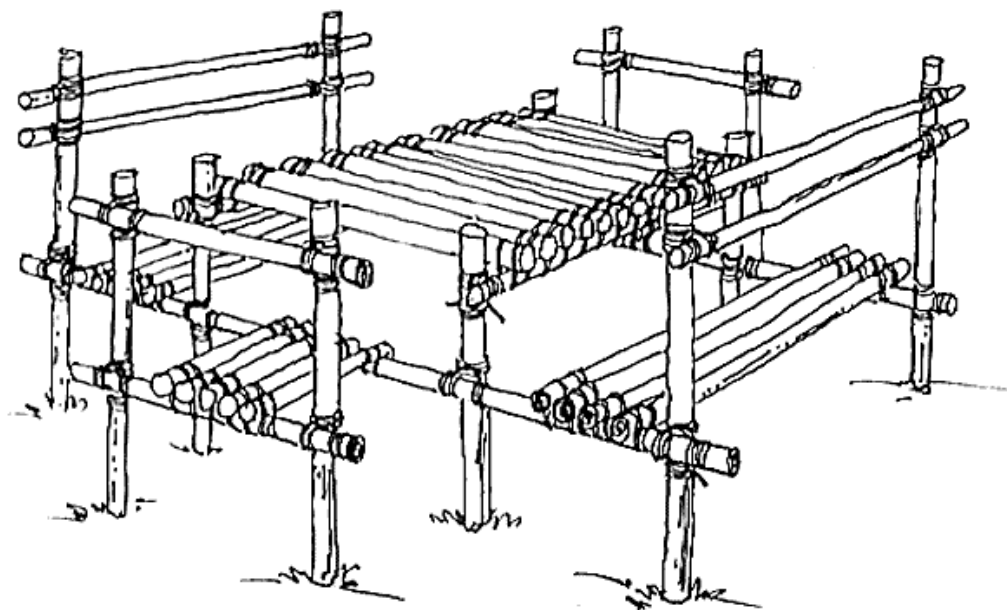

Troop Discipline?

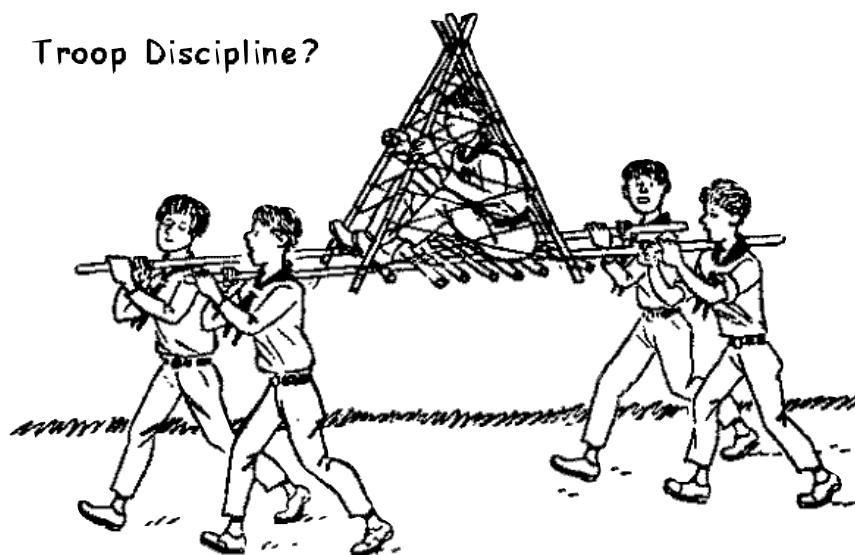

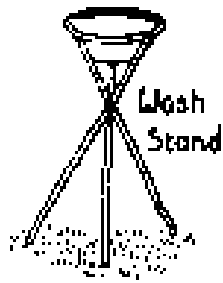

Wash Stand

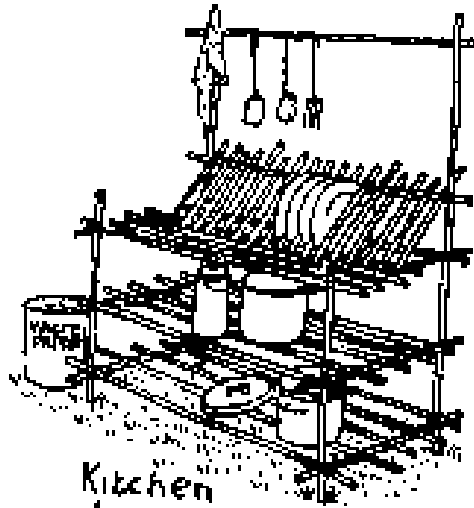

Kitchen dresser



Shoe Stand

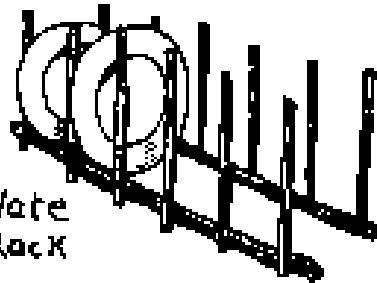
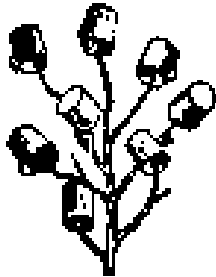

Plate Rack



Mug tree

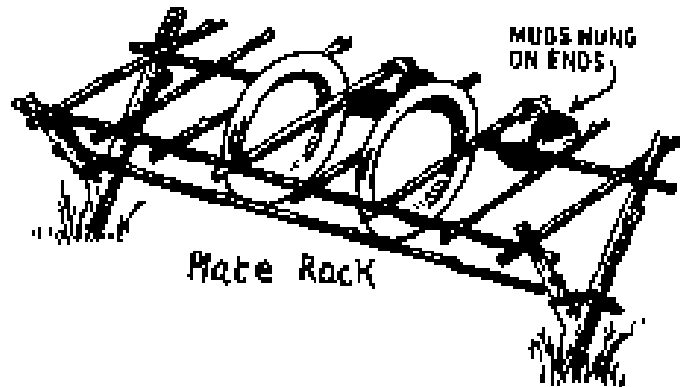
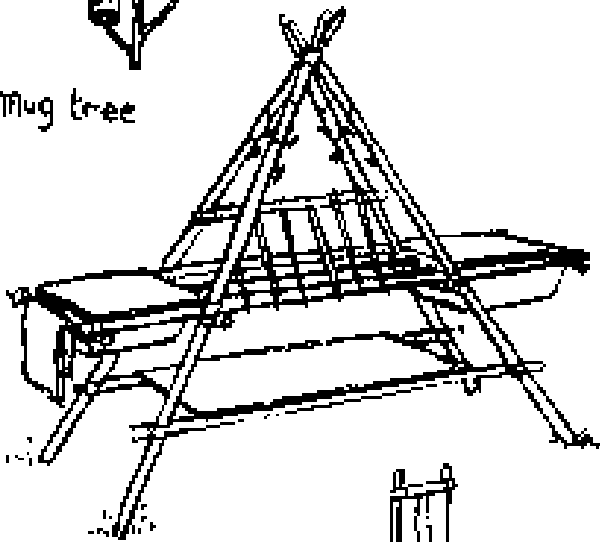
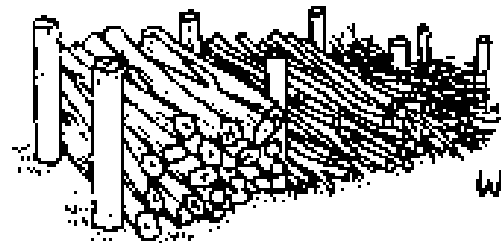

Plate Rack



Wash Stations



Woodpile

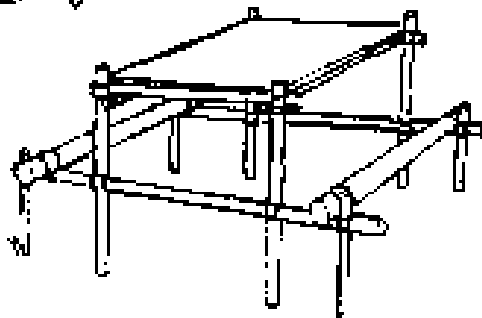
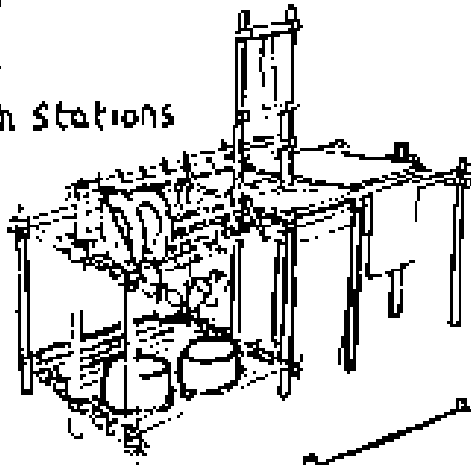

Camp tables

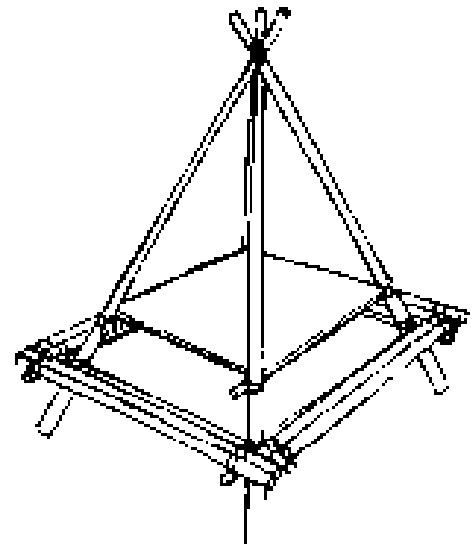

Some Traditional Camp Gadgets

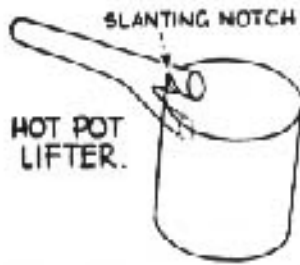

HOT POT LIFTER.

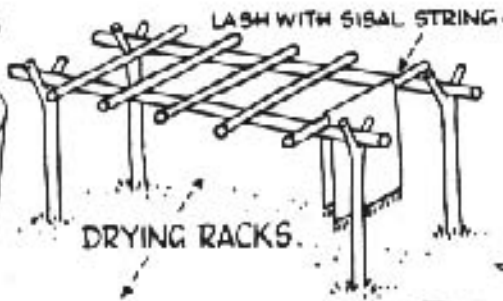

DRYING RACKS.

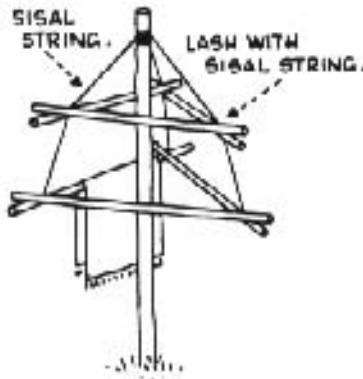

PLATE DRYER.

CLOTHES PEGS.



POT HOOK.



SISAL STRING.

LASH WITH SISAL STRING.

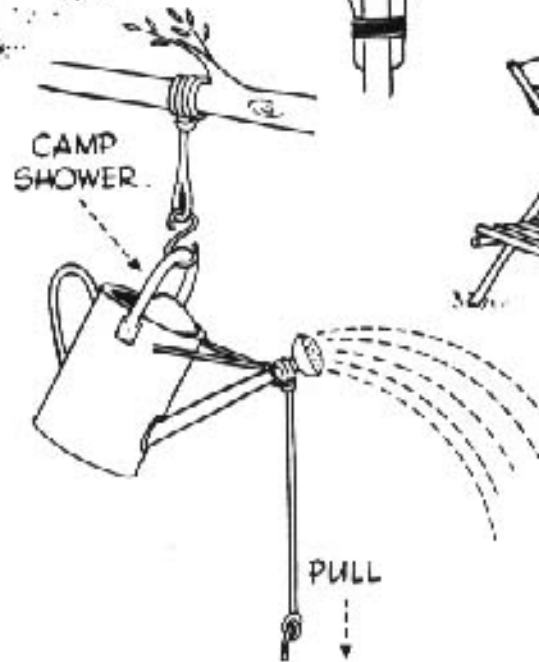

CAMP SHOWER.

PULL



WASH STAND.

317

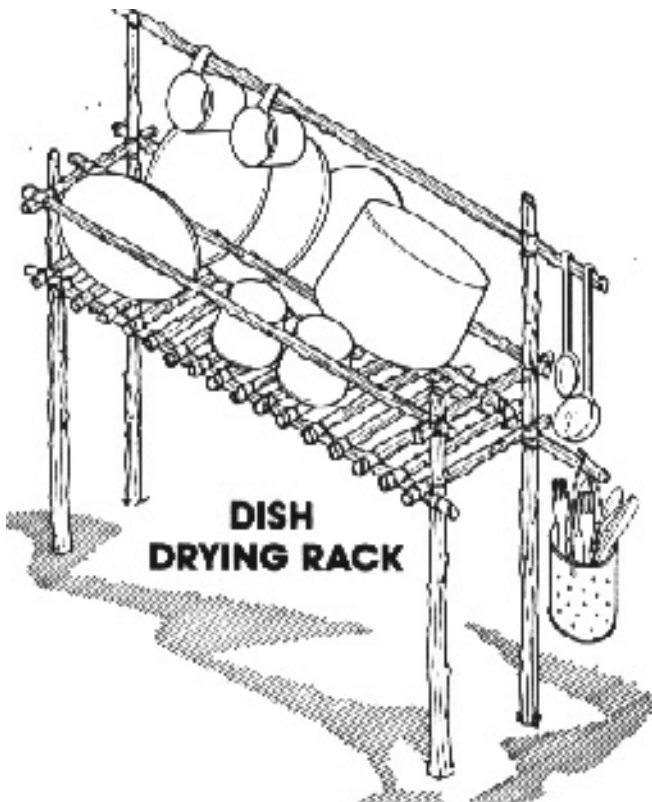

DISH DRYING RACK

Altar Fireplace

Make mud heat reflector.
Intensify heat further
by lining with foil.

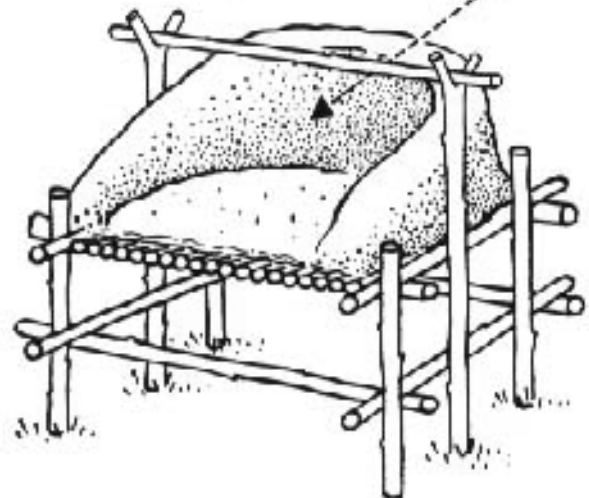

Hand Washing Rack

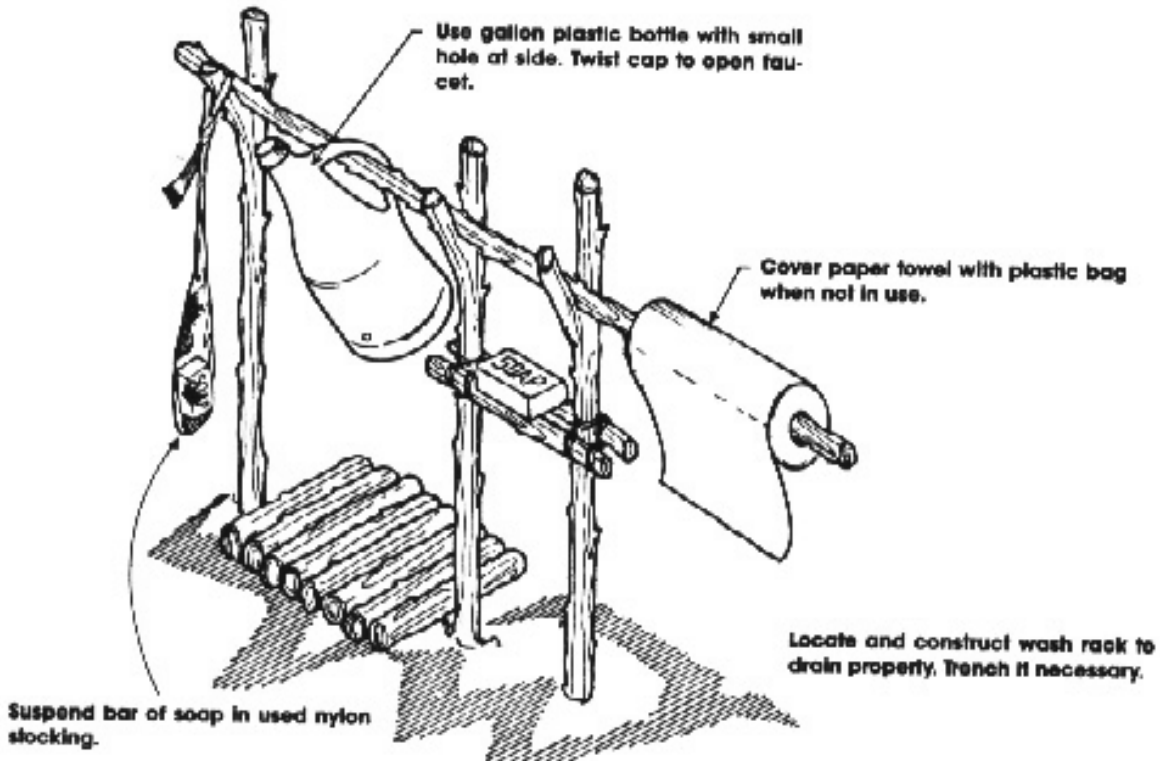

THE SINGLE LOCK BRIDGE

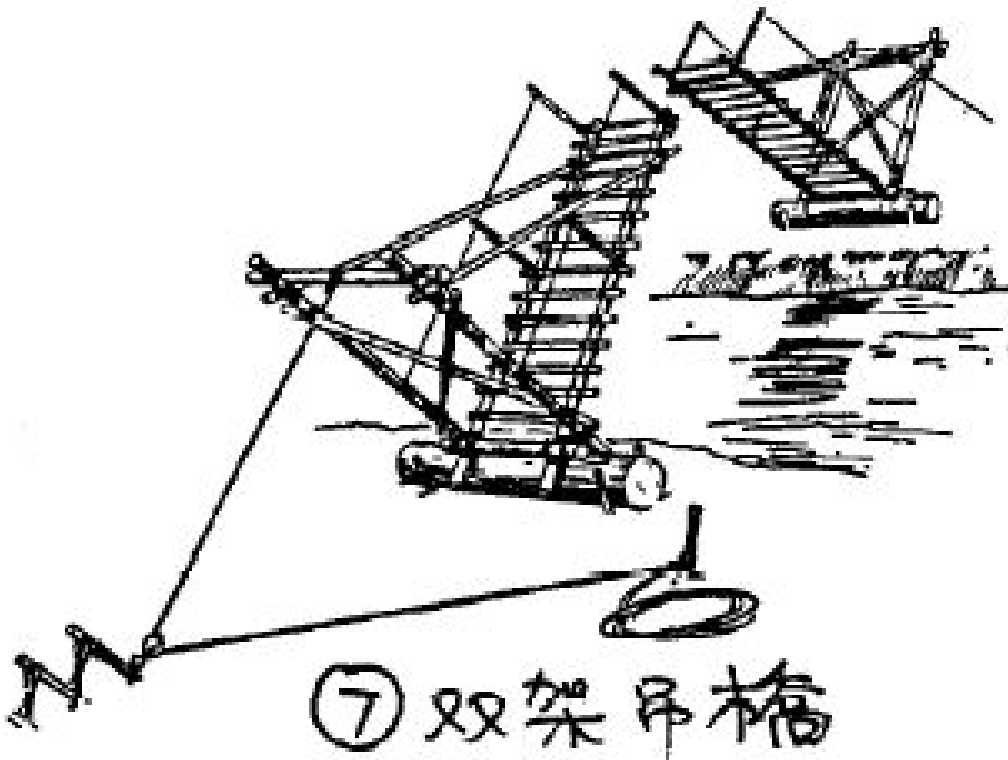

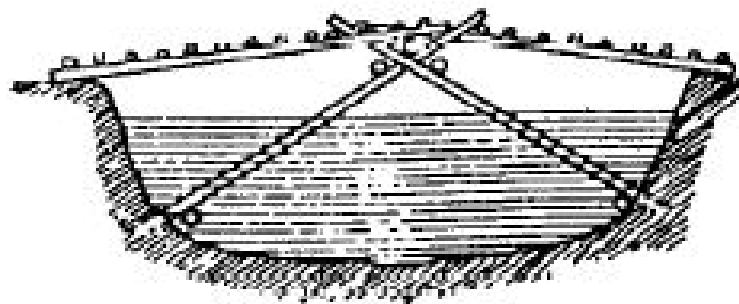
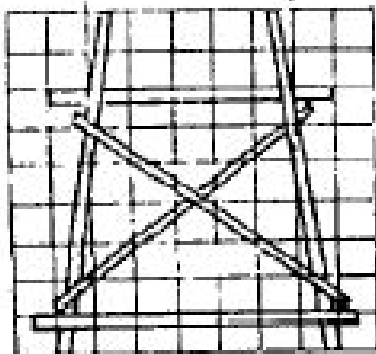
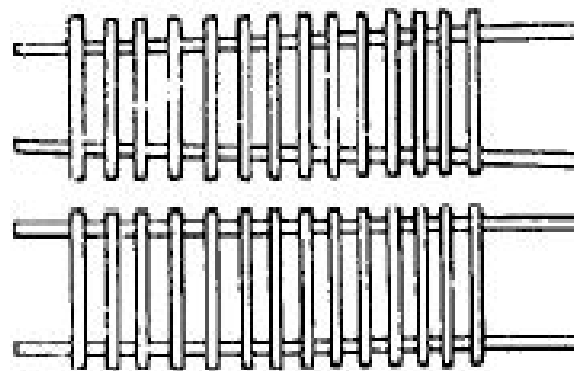
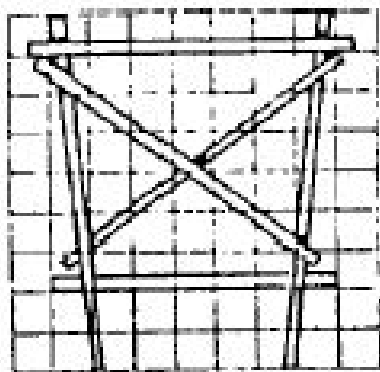
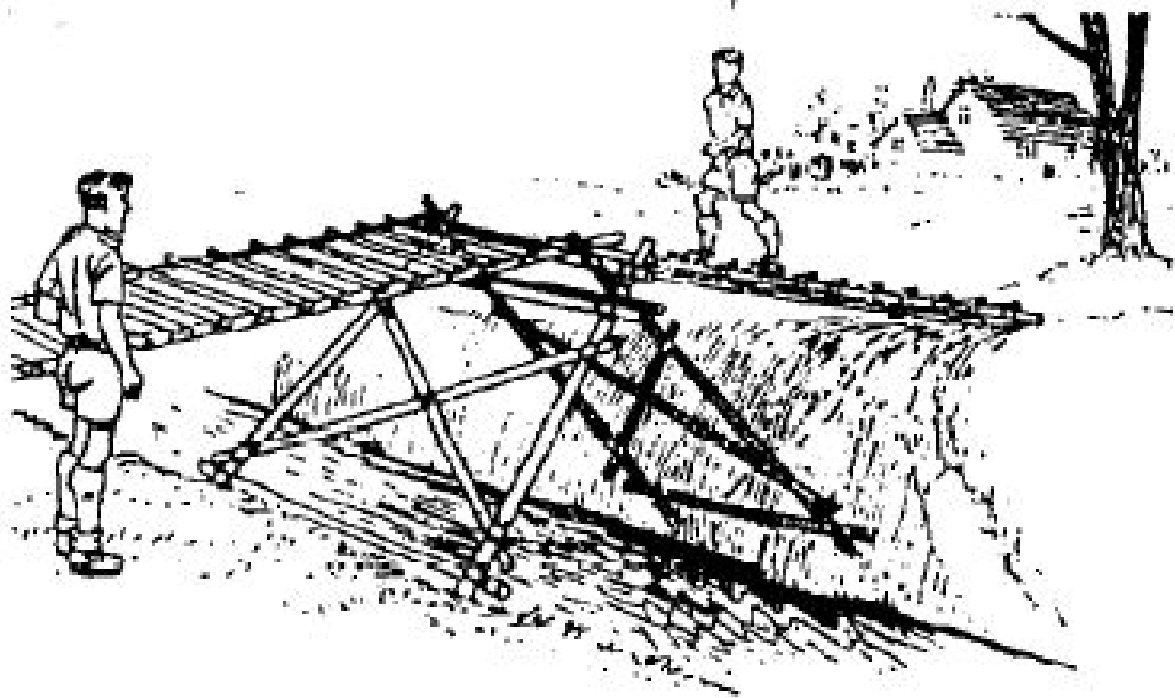

⑧ 叉架橋

THE SINGLE LOCK TRESTLE BRIDGE

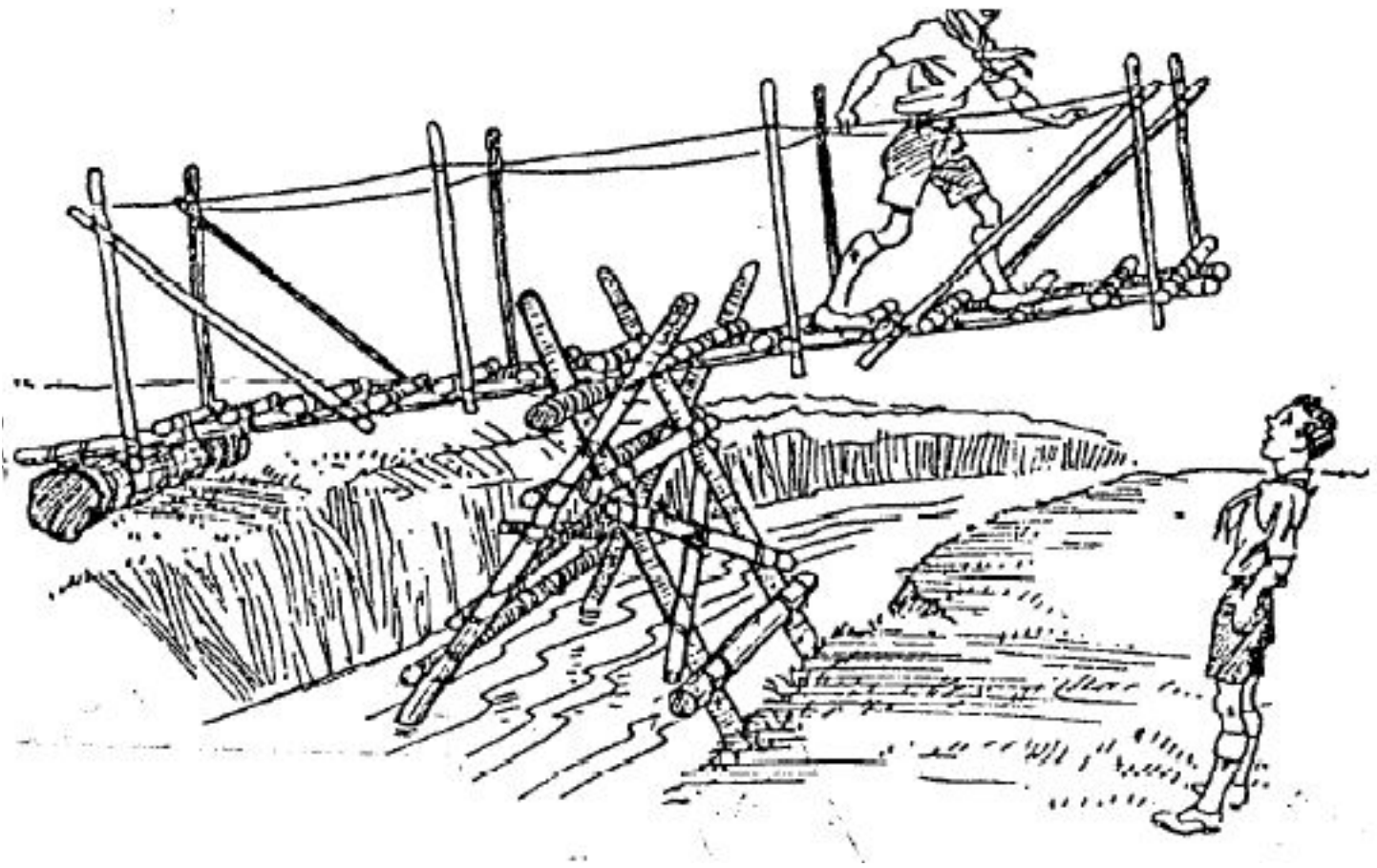

Gadgets Old and New



CANDLE HOLDER

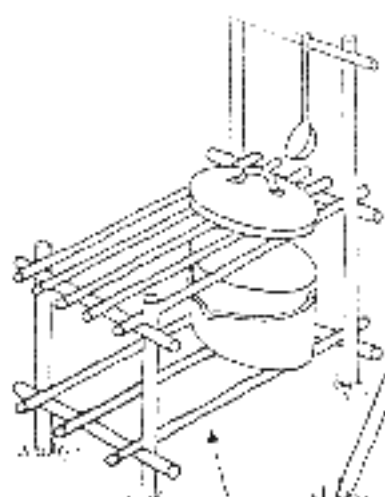

UTENSIL RACK

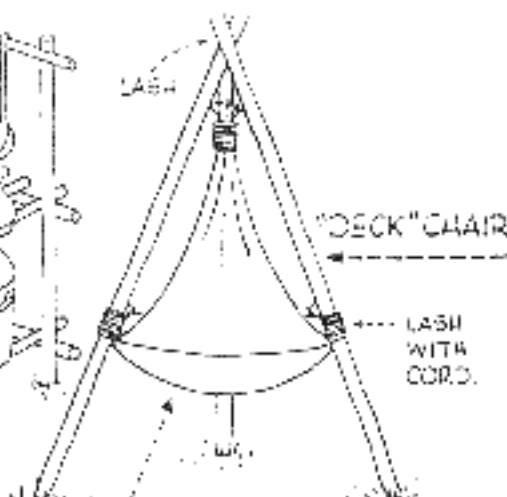

TRIANGULAR PIECE OF CANVAS OR HEAVY SACKING.

"DECK" CHAIR

LASH WITH CORD.

LASH

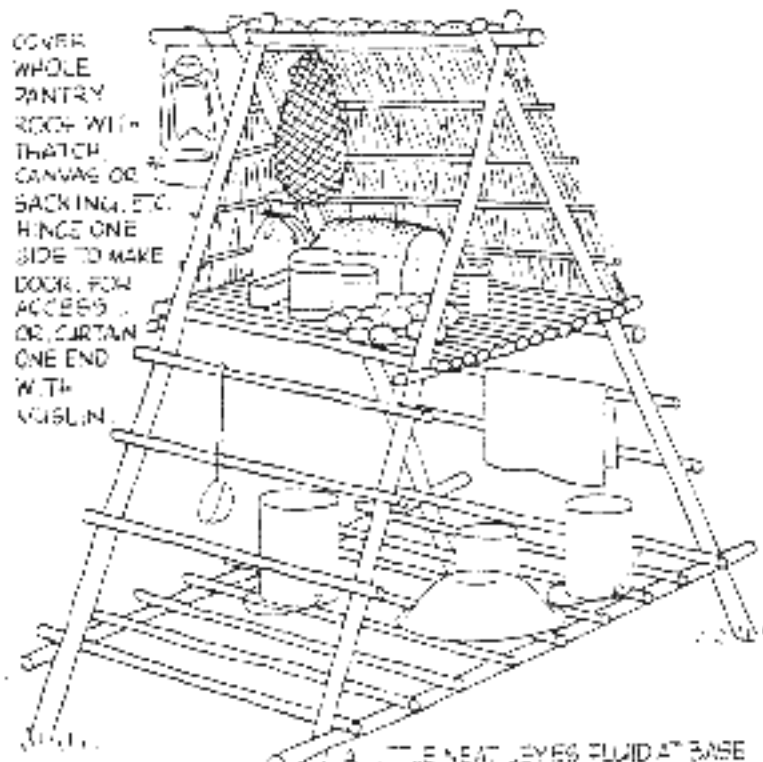

COVER WHOLE PANTRY ROOF WITH THATCH, CANVAS OR SACKING, ETC. HINGE ONE SIDE TO MAKE DOOR, FOR ACCESS. OR CURTAIN ONE END WITH MUSLIN.

ALL-IN-ONE KITCHEN UNIT.

A LITTLE NEAT JEWEL FLUID AT BASE OF EACH UPRIGHT WILL KEEP ANTS AWAY FROM THE UNIT.

SUSPENDED BOX LARDER

WOODEN BOX, OPEN BACK AND FRONT, AND SUSPENDED BY TWO ROPES PASSED THROUGH 4 HOLES BORED IN TOP, AND HELD BY KNOTS INSIDE BOX.

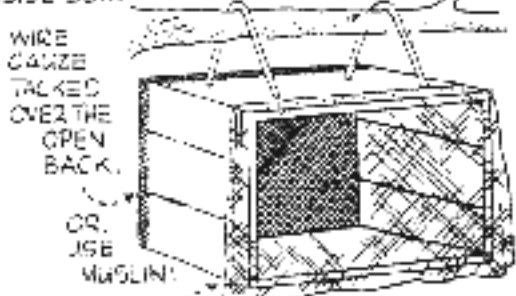

WIRE GAUZE TACKED OVER THE OPEN BACK.

OR, USE MUSLIN.

MUSLIN CURTAIN, TACKED AT TOP. HOLD CURTAIN TAUT WITH ELASTIC BAND AROUND BOX FRONT. REMOVE BAND FOR ACCESS TO LARDER. KEEP THE MUSLIN WET, FOR COOLNESS.

FUZZ-STICK

FOR STARTING A FIRE IN DAMP CONDITIONS.

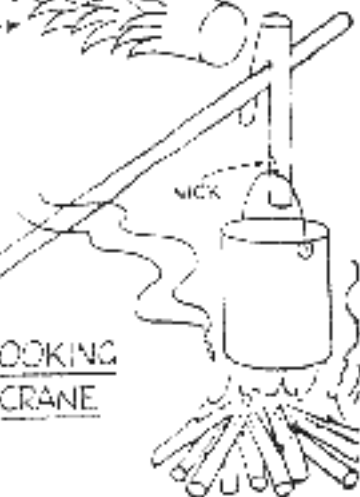

POT-FORK

FOR HANDLING POTS OF HOT LIQUID



NICK

TOASTER

- A SPLIT GREENSTICK.



POT SCRAPER

CHISEL EDGE

SHARPENED, AND DRIVEN INTO THE GROUND.

COOKING CRANE

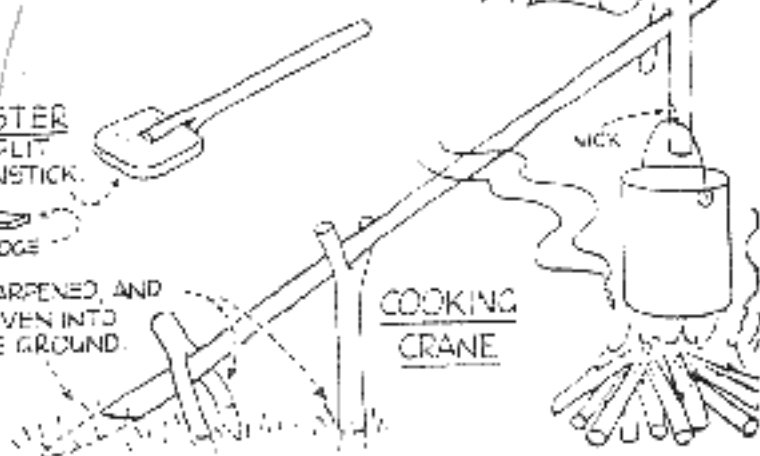

NICK

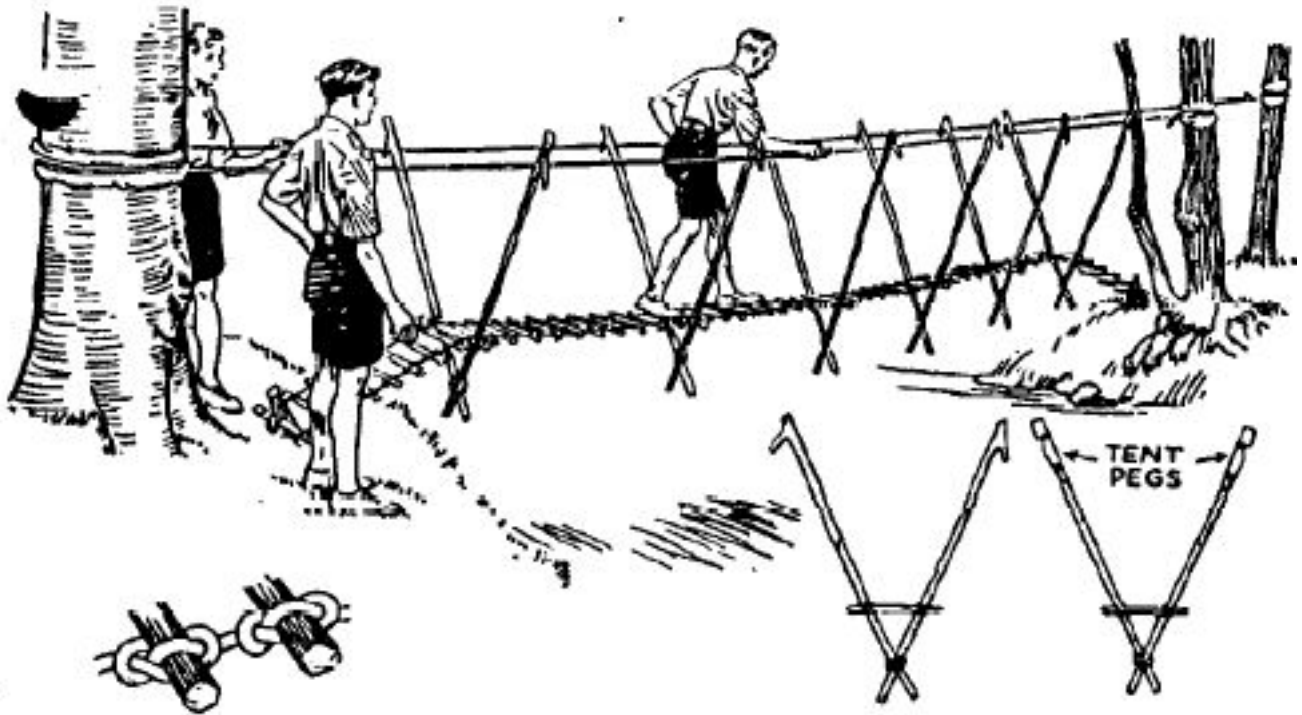

The Bushman's Bridge.



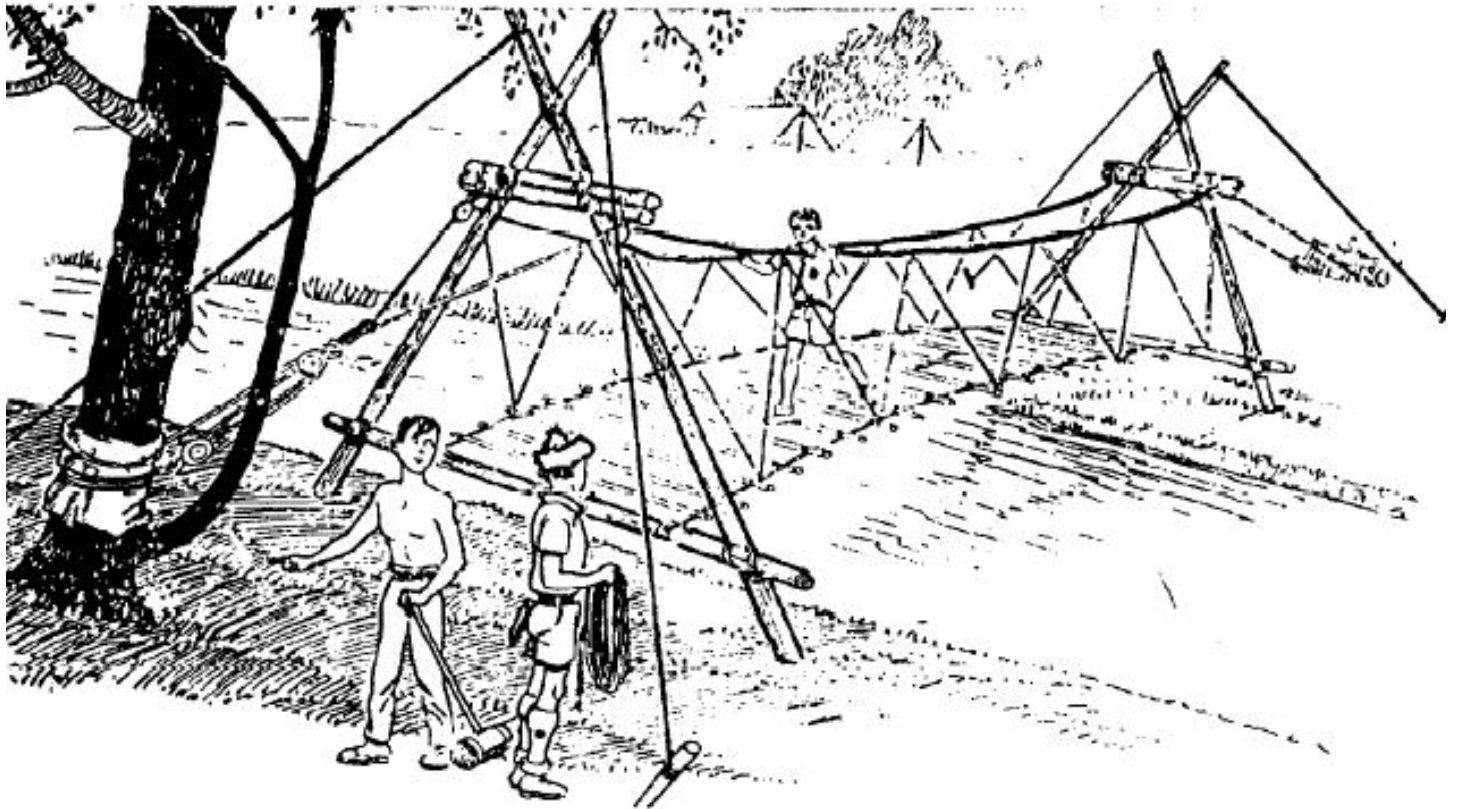

THE ABINGTON SPRING BRIDGE

15

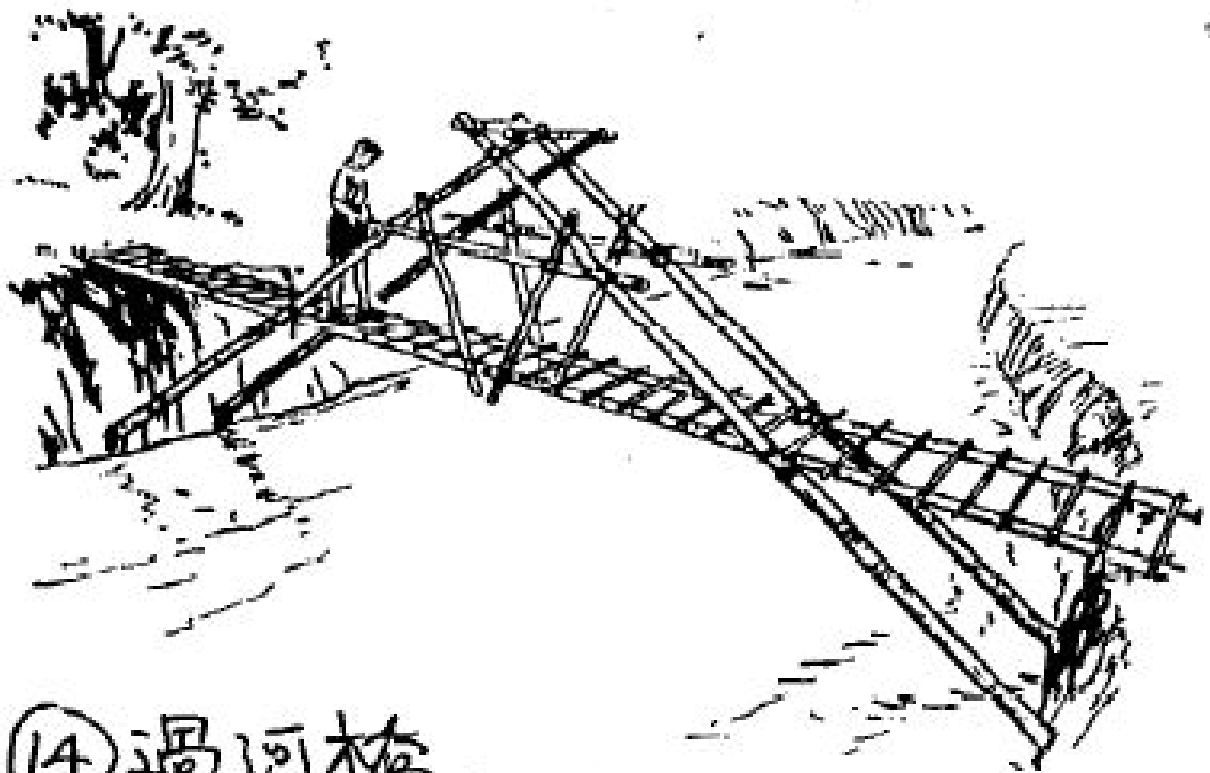

14 過河橋

Permanent Road Bridge.

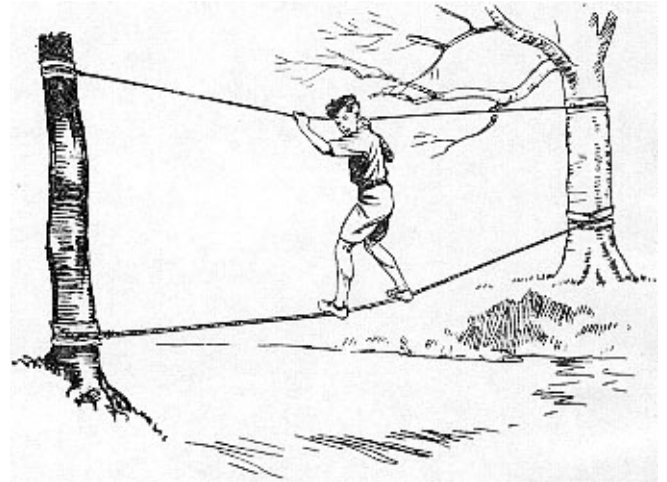
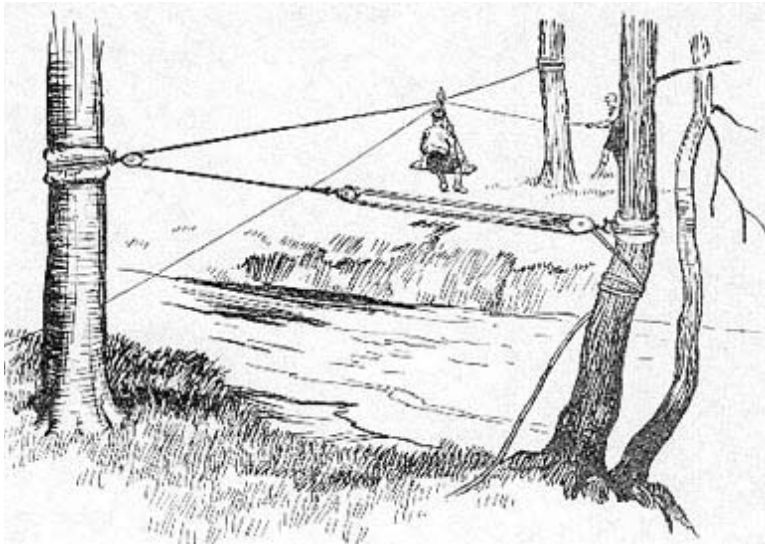

CAMP CHAIR

No rocking chair in camp but this Scouts chair will give you loads of comfort.

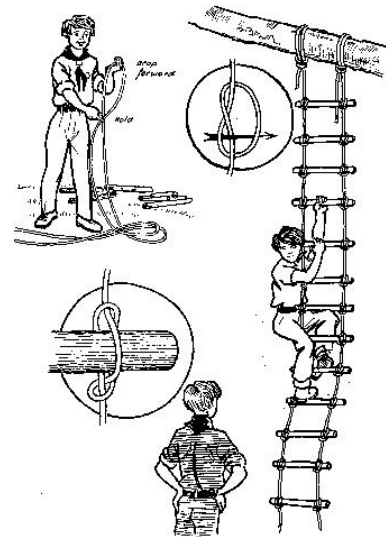

HANDY HANGER

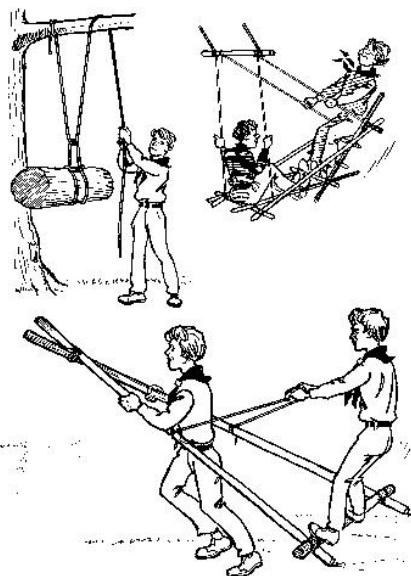

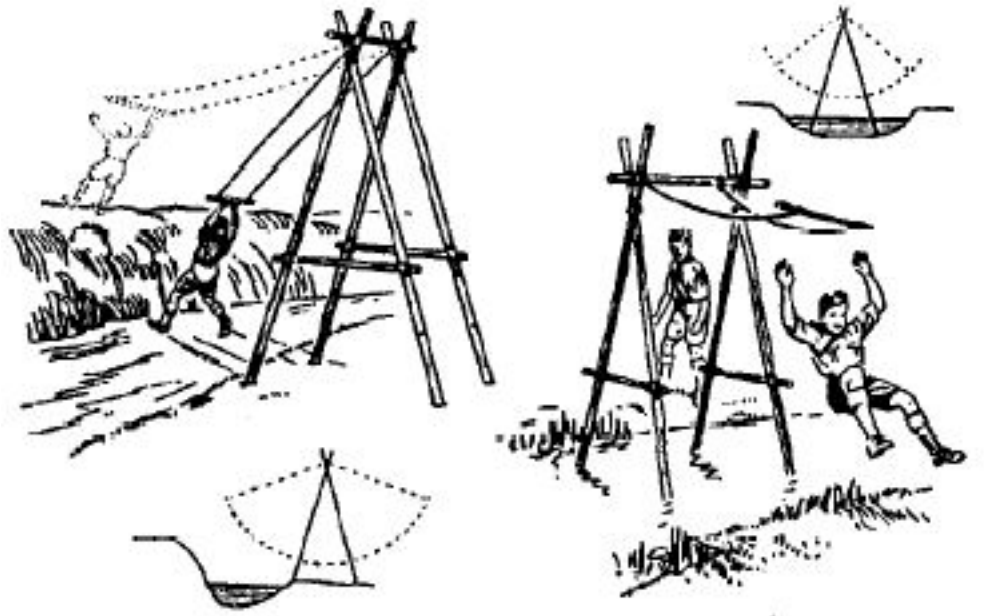
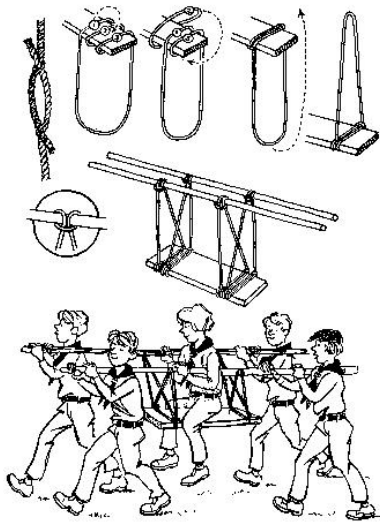

The Flying Trapeze.

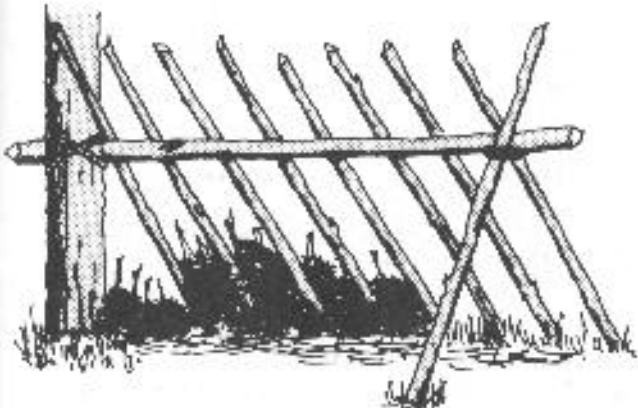
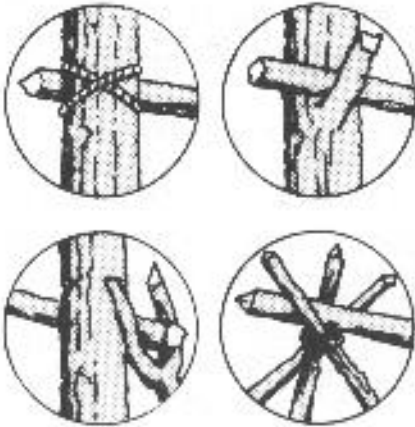

Washstand



The PATROL SKETCHBOOK

By ISHKOTEKAY

1992

"SCOUT STAVE" OR HIKING STICK

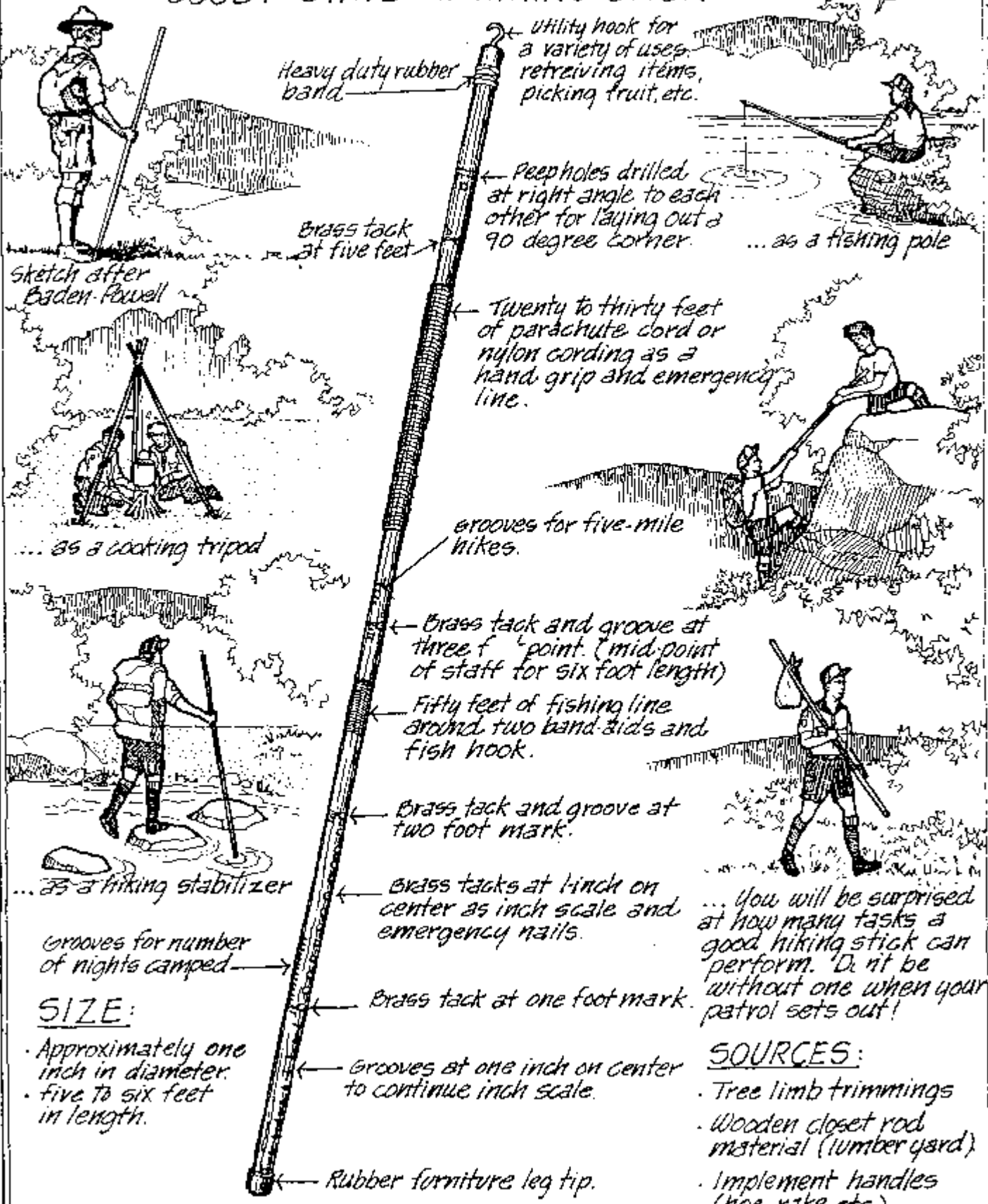

Utility hook for a variety of uses, retrieving items, picking fruit, etc.

Heavy duty rubber band

Peepholes drilled at right angle to each other for laying out a 90 degree corner.

Brass tack at five feet

Twenty to thirty feet of parachute cord or nylon cording as a hand grip and emergency line.

grooves for five-mile hikes.

Brass tack and groove at three feet point. (mid-point of staff for six foot length)

Fifty feet of fishing line around two band aids and fish hook.

Brass tack and groove at two foot mark.

Brass tacks at pinch on center as inch scale and emergency nails.

Brass tack at one foot mark.

Grooves at one inch on center to continue inch scale.

Rubber furniture leg tip.

Sketch after Baden-Powell

... as a fishing pole

... as a cooking tripod

... as a hiking stabilizer

Grooves for number of nights camped

... You will be surprised at how many tasks a good hiking stick can perform. Don't be without one when your patrol sets out!

SIZE:

- Approximately one inch in diameter.
- Five to six feet in length.

SOURCES:

- Tree limb trimmings
- Wooden closet rod material (lumber yard)
- Implement handles (hoe, rake, etc.).